

JVC



ENGLISH

РУССКИЙ

CD/CASSETTE RECEIVER

ПРИЕМНИК С ПРОИГРЫВАТЕЛЕМ КОМПАКТ-ДИСКОВ И КАССЕТ

KW-XC939

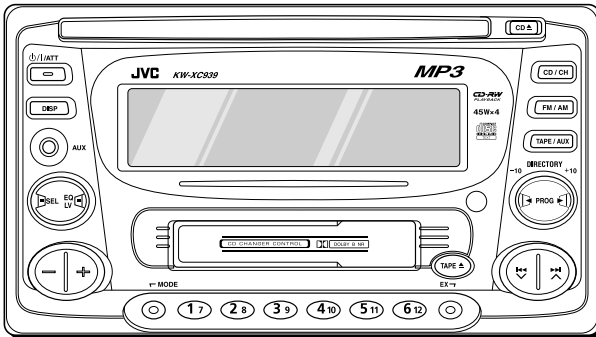
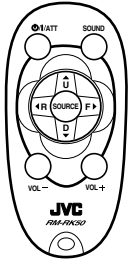

MP3



**CD-RW
PLAYBACK**

For installation and connections, refer to the separate manual.

Указания по установке и выполнению соединений приводятся в отдельной инструкции.

В соответствии с Законом Российской Федерации “О защите прав потребителей” срок службы (годности) данного товара “по истечении которого он может представлять опасность для жизни, здоровья потребителя, причинять вред его имуществу или окружающей среде” составляет семь (7) лет со дня производства. Этот срок является временем, в течение которого потребитель данного товара может безопасно им пользоваться при условии соблюдения инструкции по эксплуатации данного товара, проводя необходимое обслуживание, включающее замену расходных материалов и/или соответствующее ремонтное обеспечение в специализированном сервисном центре.

Дополнительные косметические материалы к данному товару, поставляемые вместе с ним, могут храниться в течение двух (2) лет со дня его производства.

Срок службы (годности), кроме срока хранения дополнительных косметических материалов, упомянутых в предыдущих двух пунктах, не затрагивает никаких других прав потребителя, в частности, гарантийного свидетельства JVC, которое он может получить в соответствии с законом о правах потребителя или других законов, связанных с ним.

INSTRUCTIONS ИНСТРУКЦИИ ПО ЭКСПЛУАТАЦИИ



LVT1099-001A

[EE]

IMPORTANT FOR LASER PRODUCTS

1. CLASS 1 LASER PRODUCT
2. **CAUTION:** Do not open the top cover. There are no user serviceable parts inside unit; leave all servicing to qualified service personnel.
3. **CAUTION:** Visible and invisible laser radiation when open and interlock failed or defeated. Avoid direct exposure to beam.
4. REPRODUCTION OF LABEL: CAUTION LABEL, PLACED OUTSIDE THE UNIT.

CAUTION: Visible and invisible laser radiation when open and interlock failed or defeated. AVOID DIRECT EXPOSURE TO BEAM. (e)	ADVARSEL: Synlig og usynlig laserstråling når maskinen er åben eller interlocken fejler. Undgå direkte eksponering til stråling. (e)	VARNING: Synlig och osynlig laserstråling när den öppnas och spärren är urkopplad. Betrakta ej strålen. (d)	VARO: Avaltäessa ja suojalukitus ohjeltuna tai viallisena olet alitina näkyväille ja näkymättömälle lasersäteilylle. Vältä säteen kohdistumista suoraan itsesi. (f)
--	---	--	--

CAUTION on Volume Setting

CDs produce very little noise compared with other sources. If the volume level is adjusted for the tuner, for example, the speakers may be damaged by the sudden increase in the output level. Therefore, lower the volume before playing a CD and adjust it as required during playback.

How to reset your unit

Press the reset button on the front panel using a ball-point pen or similar tool.

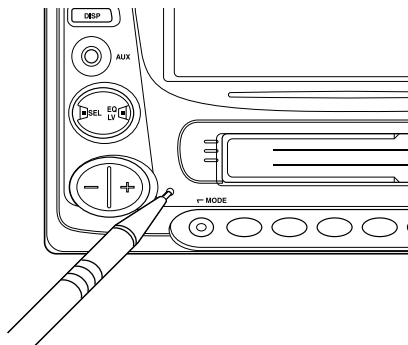

Note:

Your preset adjustments—such as preset channels or sound adjustments—will be erased.

Thank you for purchasing a JVC product. Please read all instructions carefully before operation, to ensure your complete understanding and to obtain the best possible performance from the unit.

CONTENTS

How to reset your unit	2	SOUND ADJUSTMENTS	25
LOCATION OF THE BUTTONS	4	Adjusting the sound	25
Control panel	4	Reinforcing the bass sound	25
Remote controller	5	Selecting preset sound modes	26
Preparing the remote controller	6	Storing your own sound adjustments	27
BASIC OPERATIONS	7	LEVEL METER SETTING	28
RADIO OPERATIONS	8	Selecting level meter patterns	28
Listening to the radio	8	OTHER MAIN FUNCTIONS	29
Storing stations in memory	9	About the demonstration mode	
Tuning in to a preset station	10	(DEMO MODE)	29
Other convenient tuner functions	11	Setting the clock	29
CD OPERATIONS	12	Changing general settings (PSM)	30
Playing a CD	12	Assigning names to the sources	33
Locating a track or a particular portion		EXTERNAL COMPONENT OPERATIONS ...	34
on a CD	13	CD CHANGER OPERATIONS	35
Selecting CD playback modes	14	Playing CDs	35
Playing a CD Text	15	Selecting CD playback modes	37
Other convenient CD functions	15	ADDITIONAL INFORMATION	38
MP3 INTRODUCTION	16	Handling cassettes	38
What is MP3?	16	Handling discs	39
How are MP3 files recorded and		TROUBLESHOOTING	40
played back?	16	SPECIFICATIONS	43
MP3 OPERATIONS	18		
Playing an MP3 disc	18		
Locating a file or particular portion			
on an MP3 disc	19		
Selecting MP3 playback modes	21		
TAPE OPERATIONS	22		
Listening to a tape	22		
Finding the beginning of a tune	23		
Other convenient tape functions	24		

BEFORE USE

*For safety....

- Do not raise the volume level too much, as this will block outside sounds, making driving dangerous.
- Stop the car before performing any complicated operations.

*Temperature inside the car....

If you have parked the car for a long time in hot or cold weather, wait until the temperature in the car becomes normal before operating the unit.



LOCATION OF THE BUTTONS

ENGLISH

Control panel

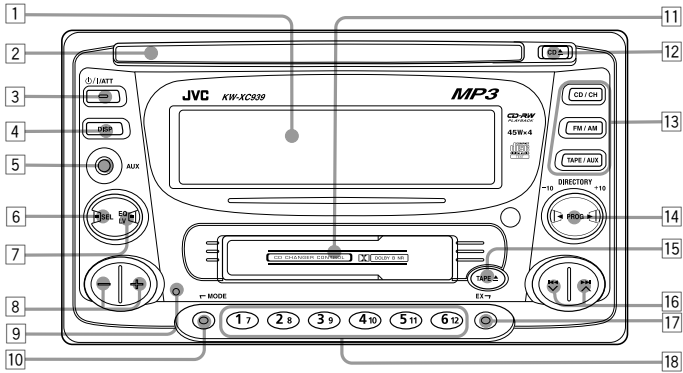

Display window

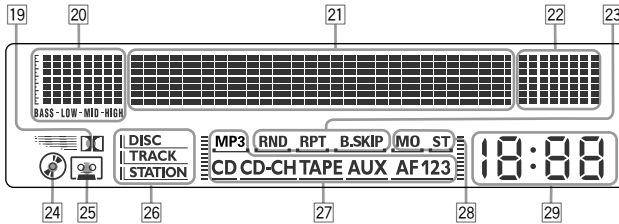

Control panel

- 1 Display window
- 2 CD loading slot
- 3 **⏻/ATT** (standby/on/attenuator) button
- 4 DISP (display) button
- 5 Auxiliary input jack
- 6 SEL (select) button
- 7 EQ LV (Equalizer/Level) button
- 8 + / - buttons
- 9 Reset button
- 10 MODE button
- 11 Cassette compartment
- 12 CD **▲** (eject) button
- 13 Source buttons
 - CD/CH button
 - FM/AM button
 - TAPE/AUX button
- 14 **◀** PROG **▶** button
 - +10 / -10 button
- 15 TAPE **▲** (eject) button
- 16 **◀◀** **▼** / **▶▶** **▲** buttons
- 17 EX (extra) button
- 18 Number buttons

Display window

- 19 Dolby NR indicator
- 20 S.BASS EQ (Super Bass/Equalizer) level / level meter
- 21 Main display
- 22 Level meter
- 23 Play mode indicators
RND (random), RPT (repeat),
B.SKIP (blank skip)
- 24 CD indicator
- 25 TAPE indicator
- 26 Text name indicators
DISC, TRACK, STATION
- 27 Source indicators
MP3, CD, CD-CH (CD-changer), TAPE, AUX,
F1, F2, F3, A
- 28 Tuner reception indicators
MO (monaural), ST (stereo)
- 29 Clock display



Remote controller

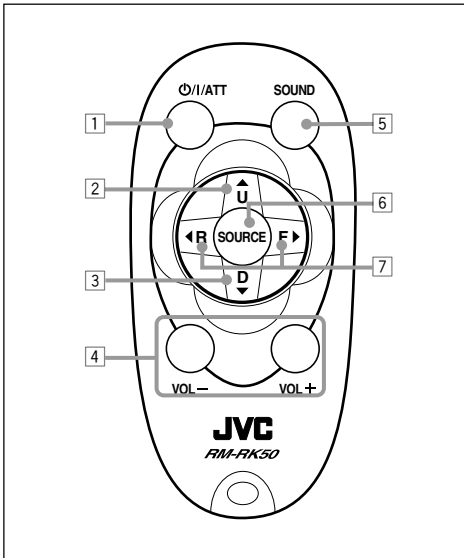

1 Functions the same as the \odot /I /ATT button on the main unit.

- 2
- Changes the band while listening to the radio.
 - Skips to the first file of the next directory if pressed while listening to an MP3 disc.
 - Changes the tape direction while listening to a tape.
 - Selects disc numbers in increasing order, and starts playing while listening to the CD changer.

- 3
- Selects preset numbers in increasing order while listening to the radio.
 - Skips to the first file of the previous directory if pressed while listening to an MP3 disc.
 - Selects disc numbers in decreasing order, and starts playing while listening to the CD changer.

- 4 Functions the same as the +/- buttons on the main unit.

Note:

These buttons do not function for the preferred setting mode (PSM) adjustment.

- 5 Selects the sound mode.
Each time you press the button, the EQ (equalizer) mode changes.
- 6 Selects the source.
Each time you press the button, the source changes.
- 7
- Searches for stations while listening to the radio.
 - Fast-forwards or reverses the track/file if pressed and held while listening to any disc.
 - Skips to the beginning of the next track/file or goes back to the beginning of the current (or previous) track/file if pressed briefly while listening to any disc.
 - Fast-forwards or rewinds a tape and finds the beginning of a tune (MMS) while listening to a tape. To release this operation, press button 2 which then starts playback.



Preparing the remote controller

Before using the remote controller:

- Aim the remote controller directly at the remote sensor on the main unit. Make sure there is no obstacle in between.
- Do not expose the remote sensor to strong light (direct sunlight or artificial lighting).

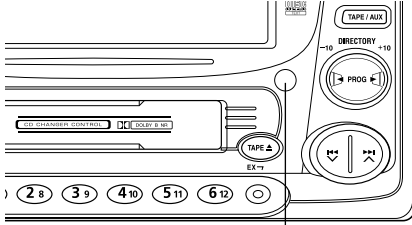

Remote sensor

Installing the battery

When the controllable range or effectiveness of the remote controller decreases, replace the battery.

1. Remove the battery holder.

- 1) Push out the battery holder in the direction indicated by the arrow using a ball-point pen or a similar tool.
- 2) Remove the battery holder.

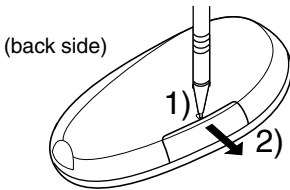

2. Place the battery.

Slide the battery into the holder with the + side facing upwards so that the battery is fixed in the holder.

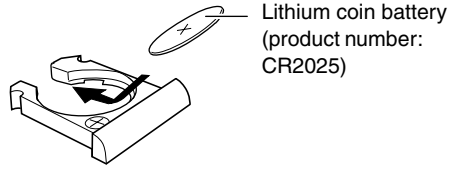

Lithium coin battery (product number: CR2025)

3. Return the battery holder.

Insert again the battery holder pushing it until you hear a clicking sound.

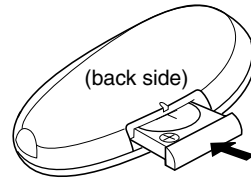

WARNING:

- Store the battery in a place where children cannot reach.
If a child accidentally swallows the battery, consult a doctor immediately.
- Do not recharge, short, disassemble or heat the battery or dispose it in a fire.
Doing any of these things may cause the battery to give off heat, crack or start a fire.
- Do not leave the battery with other metallic materials.
Doing this may cause the battery to give off heat, crack or start a fire.
- When throwing away or saving the battery, wrap it in tape and insulate; otherwise, the battery may start to give off heat, crack or start a fire.
- Do not poke the battery with tweezers or similar tools.
Doing this may cause the battery to give off heat, crack or start a fire.

CAUTION:

DO NOT leave the remote controller in a place (such as dashboards) exposed to direct sunlight for a long time. Otherwise, it may be damaged.

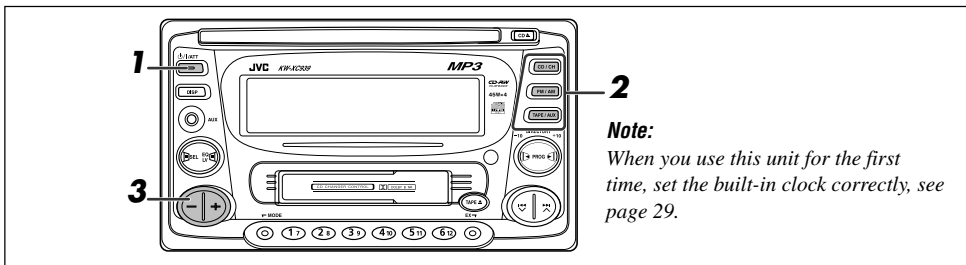

Note:

When you use this unit for the first time, set the built-in clock correctly, see page 29.

1 Turn on the power.

 / I / ATT "HELLO!" appears on the display.

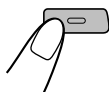

Note on One-Touch Operation:

When you select a source in step 2 below, the power automatically comes on. You do not have to press this button to turn on the power.

2 Select the source.



- Each time you press CD/CH, the source alternates between CD* and CD-changer (or external component)**.



- Each time you press FM/AM, the band changes to FM (FM1, FM2, FM3) and AM.



- Each time you press TAPE/AUX, the source alternates between TAPE*** and external component (AUX INPUT).

* If a disc is not in the loading slot, you cannot select CD as the source to play. ("NO DISC" will appear on the display.)

** Without connecting the CD changer or the external component, you cannot select it as the source to play.

*** If a cassette is not in the cassette compartment, you cannot select TAPE as the source to play. ("NO TAPE" will appear on the display.)

To operate the tuner, see pages 8 – 11.
 To play the CD, see pages 12 – 15.
 To play an MP3 disc, see pages 18 – 24.
 To operate the tape deck, see pages 22 – 24.
 To operate the external components, see page 34.
 To operate the CD changer, see pages 35 – 37.

3 Adjust the volume.

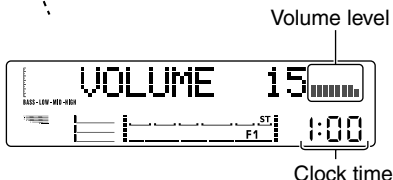
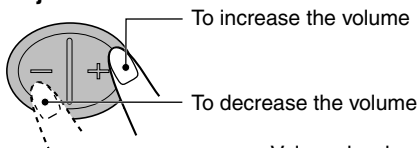

4 Adjust the sound as you want (see pages 25 – 27).

- If you need to change the level meter pattern, see page 28.

To drop the volume immediately

Press  / I / ATT briefly while listening to any source. "ATT" starts flashing on the display, and the volume level will drop immediately. To resume the previous volume level, press the button briefly again.

To turn off the power

Press  / I / ATT for more than 1 second. "SEE YOU" appears, then the unit turns off.

- If you turn off the power while listening to a disc, the disc play will start from where playback has been stopped previously, next time you turn on the power.
- If you turn off the ignition key without turning off this unit, the unit will automatically turn on when you turn on the ignition key next time. If the last selected source is ready for playback (ex. a disc or a tape is in the unit), playback starts automatically.

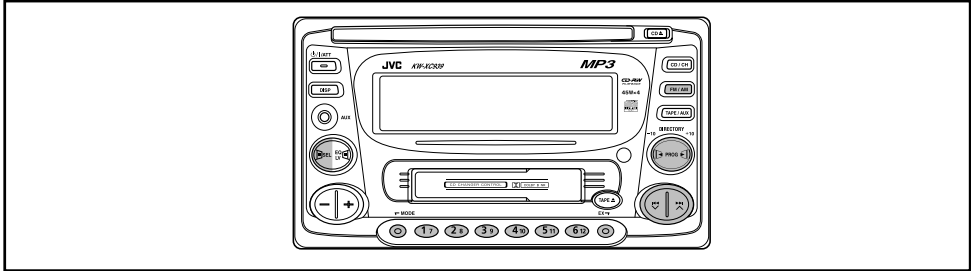

Listening to the radio

You can use either automatic searching or manual searching to tune in to a particular station.

Searching for a station automatically: Auto search

- 1 Select the band (FM1, FM2, FM3 or AM).

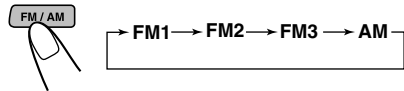

Note:

This receiver has three FM bands (FM1, FM2, and FM3). You can use any one of them to listen to an FM broadcast.

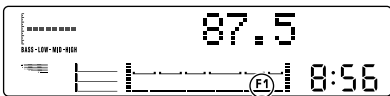

Selected band appears.

- 2 Start searching for a station.

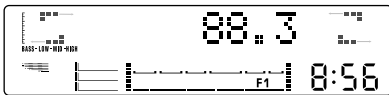
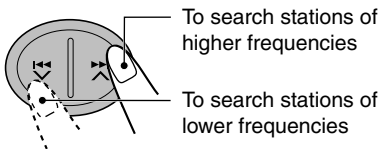

When a station is received, searching stops.

To stop searching before a station is received, press the same button you have pressed for searching.

Searching for a station manually: Manual search

- 1 Select the band (FM1, FM2, FM3, or AM).

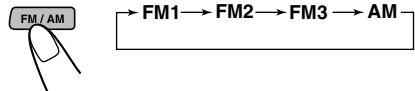

- 2 Press and hold $\blacktriangleright\blacktriangleright$ \blacktriangle or $\blacktriangleleft\blacktriangleleft$ \blacktriangledown until "M" (manual) starts flashing on the display.

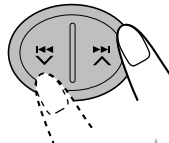

- 3 Tune in to a station you want while "M" is flashing.

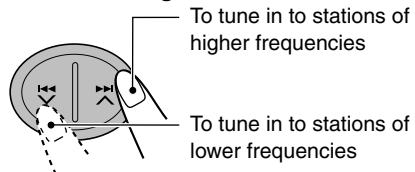

- If you release your finger from the button, the manual mode will automatically turn off after 5 seconds.
- If you hold down the button, the frequency keeps changing (in 50 kHz intervals for FM and 9 kHz for AM) until you release the button.

Storing stations in memory

You can use one of the following methods to store broadcasting stations in memory.

- Automatic preset: SSM (Strong-station Sequential Memory)
- Manual preset
- Storing your favorite station into the EX button

Automatic preset: SSM

You can preset up to 6 local stations in each FM band (FM1, FM2, and FM3).

1 Select the band (FM1, FM2, or FM3).

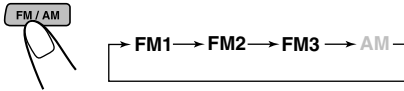

2 Press MODE repeatedly until "SSM" appears.

MODE

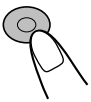

3 Press SEL (select).



"--SSM--" appears, then disappears when automatic preset is over.

Local stations with the strongest signals are searched for and stored automatically in the band you have selected (FM1, FM2, and FM3). These stations are preset in the number buttons—No. 1 (lowest frequency) to No. 6 (highest frequency).

When automatic preset is over, the station stored in the number 1 button will be automatically tuned in.

Manual preset

You can preset up to 6 stations in each band (FM1, FM2, FM3, and AM) manually.

Ex.: Storing an FM station of 88.3 MHz into the preset channel number 1 of the FM1 band

1 Select the FM1 band.



2 Tune in to a station (in this example, of 88.3 MHz).

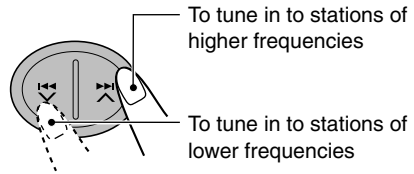

3 Press and hold the number button (in this example, 1) for more than 2 seconds.



"P1" flashes for a few seconds.

4 Repeat the above procedure to store other stations into other preset numbers.



Storing your favorite station into the EX (extra) button

You can preset an FM or AM station (such as your favorite station or traffic announcement station); and recall it by one touch operation even if the unit is turned off.

Ex.: Storing an FM station of 88.3 MHz into the EX button

1 Select the FM1 band.



2 Tune in to a station (in this example, of 88.3 MHz).

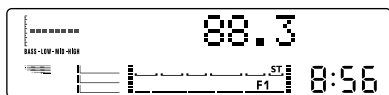
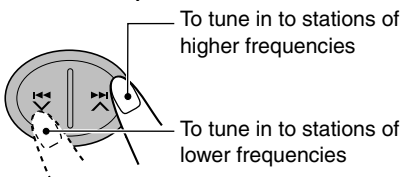

3 Press and hold the EX (extra) button until "EX" flashes.



"EX" flashes on the display.

Notes:

- The previously preset station is erased when a new station is stored.
- Preset stations are erased when the power supply to the memory circuit is interrupted (for example, during battery replacement). If this occurs, preset the stations again.

Tuning in to a preset station

You can easily tune in to a preset station. Remember that you must store stations first. If you have not stored them yet, see page 9.

1 Select the band (FM1, FM2, FM3, or AM) you want.

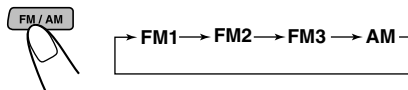

2 Select the number (1 - 6) for the preset station you want.

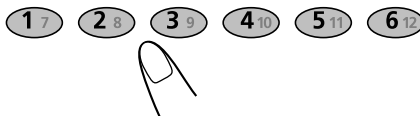

To tune in the favorite station (EX)

EX Press EX (extra) so that the unit automatically turns on (if it has been off). Your favorite station is tuned in.

- If you press the button again, the previous source will be played back again.

Other convenient tuner functions

Scanning broadcast stations

1 Select "SCAN."

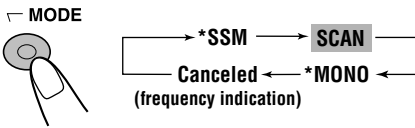

* When receiving an FM stereo broadcast.

2 Start scanning.

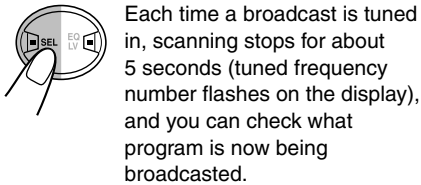

If you want to listen to that program, press MODE button again to stop scanning.

Showing an assigned name

If you have assigned a name to a station frequency, the display shows its assigned name after the station frequency is displayed. When the station name is displayed, the STATION indicator lights up on the display (see page 33).

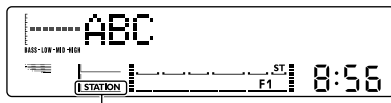

Lights up

To confirm the station frequency while the assigned name is shown, press DISP (display). Each time you press the button, the assigned name and the station frequency alternate on the display.

Note:

If no name is assigned, "NO NAME" will appear when you press DISP (display).

Selecting FM reception mode

When an FM stereo broadcast is hard to receive, follow the procedure below:

1 Select "MONO."

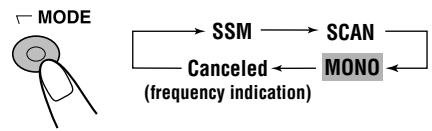

2 Select FM reception mode.

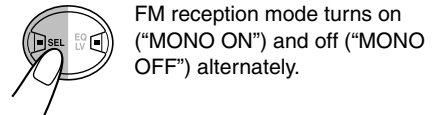

When the monaural mode is turned on, the sound you hear becomes monaural but reception will be improved.

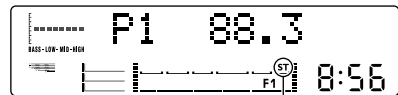

Lights up when receiving an FM broadcast in stereo.





CD OPERATIONS

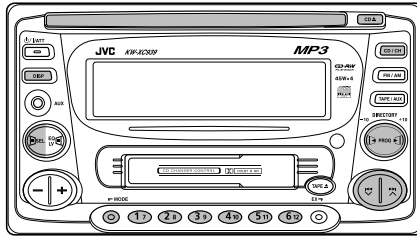

Playing a CD

1 Insert a disc into the loading slot.

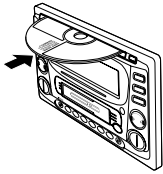

The unit turns on, draws in the CD and starts playback automatically.



CD indicator lights up.

Total track number of the inserted disc Total playing time of the inserted disc



Current track Elapsed playing time



Note on One-Touch Operation:

When a CD is already in the loading slot, pressing CD/CH turns on the unit and starts playback automatically.

Notes:

- When a CD is inserted upside down, the CD automatically ejects.
- When you play a CD Text, the disc title and performer appear on the display. Then the current track title appears on the display, followed by the track number and elapsed playing time. See also "Playing a CD Text" (page 15) and "Selecting the scroll mode—SCROLL" (page 32).
If a CD Text includes much text information, some may not appear on the display.
- If you play a CD with assigned name (see page 33), the assigned name appears on the display, followed by the track number and elapsed playing time. See also "Showing an assigned name" on page 15.

To stop play and eject the CD

Press CD ▲.

CD play stops and the CD automatically ejects from the loading slot ("EJECT" appears on the display). The source changes to the last selected source.

Notes:

- If the ejected disc is not removed for about 15 seconds, the disc is automatically inserted again into the loading slot to protect it from dust. (CD play will not start this time.)
- You can eject the CD even when the unit is turned off.
- If you change the source, CD play also stops (without ejecting the disc).
Next time you select "CD" as the source, CD play starts from where playback had been stopped previously.



Locating a track or a particular portion on a CD

To fast-forward or reverse the track

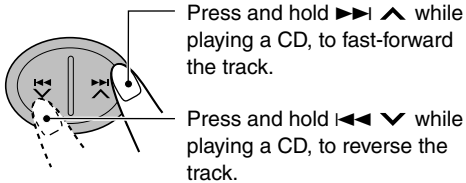

Press and hold **▶▶▶ ▲** while playing a CD, to fast-forward the track.

Press and hold **◀◀◀ ▼** while playing a CD, to reverse the track.

To skip 10 tracks

MODE 1 Press MODE repeatedly until "◀-10 +10▶" appears.

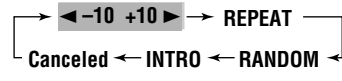
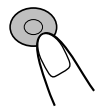

2 Press +10 or -10 button.

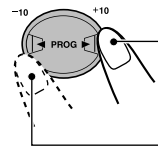

To skip 10 tracks* forwards to the last track

To skip 10 tracks* backwards to the first track

* The first time you press +10 or -10 button, the track skips to the nearest higher or lower track with a track number of multiple ten (ex. 10th, 20th, 30th).

Then each time you press the button, you can skip 10 tracks (see "How to use the +10 and -10 buttons" below).

- After the last track, the first track will be selected, and vice versa.

To go to the next tracks or the previous track

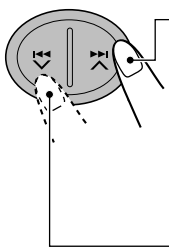

Press **▶▶▶ ▲** briefly while playing a CD, to go ahead to the beginning of the next track. Each time you press the button consecutively, the beginning of the next track is located and played back.

Press **◀◀◀ ▼** briefly while playing a CD, to go back to the beginning of the current track. Each time you press the button consecutively, the beginning of the previous track is located and played back.

To go to a particular track directly

Press the number button corresponding to the track number to start its playback.

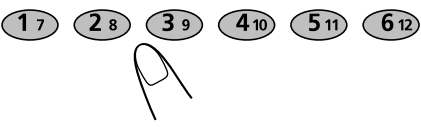

- To select a track number from 1 – 6: Press 1 (7) – 6 (12) briefly.
- To select a track number from 7 – 12: Press and hold 1 (7) – 6 (12) for more than 1 second.

How to use the +10 and -10 buttons

• Ex. 1: To select track number 32 while playing track number 6

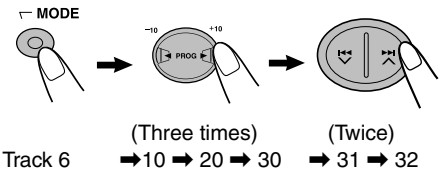

• Ex. 2: To select track number 8 while playing track number 32

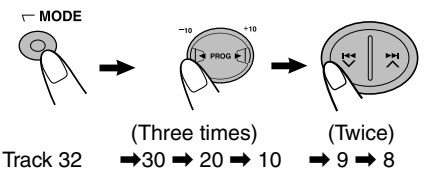



Selecting CD playback modes

To play back tracks repeatedly (Repeat Play)

You can play back the current track repeatedly.

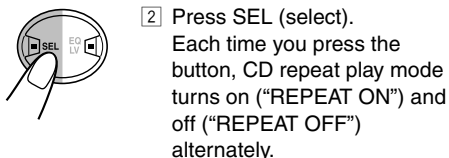
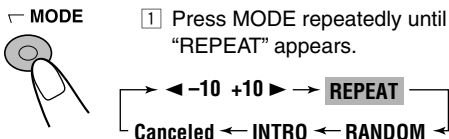

When the repeat mode is turned on, the RPT indicator lights up on the display.

To play back tracks at random (Random Play)

You can play back all tracks on the CD at random.

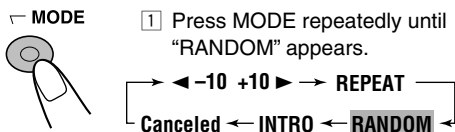

- 2 Press SEL (select). Each time you press the button, CD random play mode turns on ("RANDOM ON") and off ("RANDOM OFF") alternately.

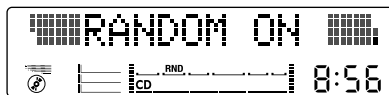

When the random mode is turned on, the RND indicator lights up on the display and a randomly selected track starts playing.

To play back only intro (Intro scan)

You can play back the first 15 seconds of each track sequentially.

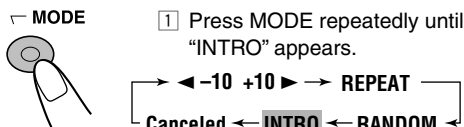

- 2 Press SEL (select). Each time you press the button, CD Intro scan mode turns on ("INTRO ON") and off ("INTRO OFF") alternately.

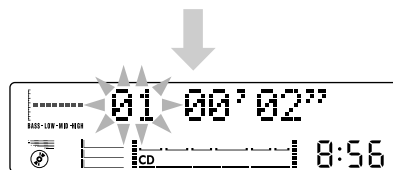
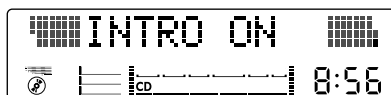

When the Intro scan mode is turned on, the current track number flashes.



Playing a CD Text

In a CD Text, some information about the disc (its disc title, performer and track title) is recorded. You can show these disc information on the display.

1 Select text display mode while playing a CD Text.



Each time you press the button, the display changes as follows:



When disc information appears on the display, the corresponding name indicator lights up.

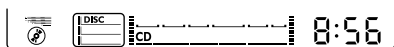

When a disc title/performer is displayed.

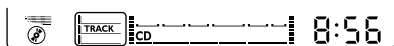

When a track title is displayed.

Notes:

- You can use the scroll mode to show the disc information on the display. See also "Selecting the scroll mode—SCROLL" on page 32.
- When you press DISP (display) while playing a conventional CD, "NO NAME" appears for the disc title/performer (unless you have assigned a name to the CD) and the track title.

Other convenient CD functions

Showing an assigned name

You can assign names to conventional CDs. If you have assigned a name to a CD, the assigned name appears on the display, followed by the current track number and elapsed playing time.

When the CD name is displayed, the DISC indicator lights up on the display (see page 33).

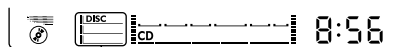

Lights up

To confirm the current track number and elapsed playing time while the assigned name is shown, press DISP (display).

Each time you press the button, the assigned name and current track number/elapsed playing time alternate on the display.

Note:

You cannot assign a name to a CD Text or an MP3 disc.

Prohibiting CD ejection

You can prohibit CD ejection and can lock a CD in the loading slot.



While pressing CD/CH, press and hold CD ▲ for more than 2 seconds. "CD ▲" flashes on the display for a while, and the CD is locked and cannot be ejected.

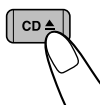

To cancel the prohibition and unlock the CD, press and hold CD ▲ for more than 2 seconds again, while pressing CD/CH. "EJECT OK" flashes on the display for a while, and the CD is unlocked.



MP3 INTRODUCTION

What is MP3?

MP3 is an abbreviation of Motion Picture Experts Group (or MPEG) Audio Layer 3*. MP3 is simply a file format with a data compression ratio of 1:10 (128 Kbps**). That means, by using MP3 format, one CD-R or CD-RW can contain 10 times as much data volume as a regular CD can.

* This player is not compatible with the data encoded with Layer 1 and 2 formats.

** Bit rate is the average number of bits that one second of audio data will consume. The unit used is Kbps (1024 bits/second). To get a better audio quality, choose a higher bit rate. The most popular bit rate for encoding is 128 Kbps.

An MP3 decoder is incorporated into this unit. You can play back MP3 files (tracks) recorded on CD-Rs, CD-RWs, and CD-ROMs.

Compatible with ID3v1

Extra information data such as album title, performer name, song title, recording year, music genre and a brief comment can be stored within an MP3 file.

This unit can show ID3v1 tags (album name, performer name and song title) on the display.

- Some characters cannot be shown correctly.
- This unit is not compatible with ID3v2.

Other main features in this unit:

- Maximum number of directories/files: 289 (Total)
- Available characters: A–Z, 0–9, _(underscore)
- Maximum number of characters for file name (ISO 9660 Level 1): 12 (inclusive of separation mark—“.” and extension code—“mp3”)
- (ISO 9660 Level 2): 31 (inclusive of separation mark—“.” and extension code—“mp3”)
- (Joliet): 64 (inclusive of separation mark—“.” and extension code—“mp3”)
- Maximum number of characters for directory name: 64

Precautions when recording MP3 files on a CD-R or CD-RW

This unit can only read MP3 files that are recorded in the format that is compliant with ISO 9660 Level 1, Level 2 or Joliet.

How are MP3 files recorded and played back?

MP3 “files (tracks)” can be recorded in “directories (folders)”—in PC terminology. During recording, the files and directories can be arranged in a way similar to arranging files and directories/folders of computer data. “Root” is similar to the root of a tree. Every file and directory can be linked to and be accessed from the root.

Playback order, file search order, and directory search order of the MP3 files recorded on a disc are determined by the writing (or encoding) application; therefore, playback order may be different from the one you have intended while recording the directories and the files.



The illustration on the next page shows an example of how MP3 files are recorded on a CD-R or CD-RW, how they are played back, and how they are searched for on this unit.

Notes:

- The unit can read a CD-ROM containing MP3 files. However, if non-MP3 files are recorded together with MP3 files, this unit will take a longer time to scan the disc. It may also cause the unit to malfunction.
 - The unit cannot read or play an MP3 file without the extension code—mp3.
 - The unit is not compatible with Playlist*.
- * A playlist is a simple text file, used on a PC, which enables users to make their own playback order without physically rearranging the files.

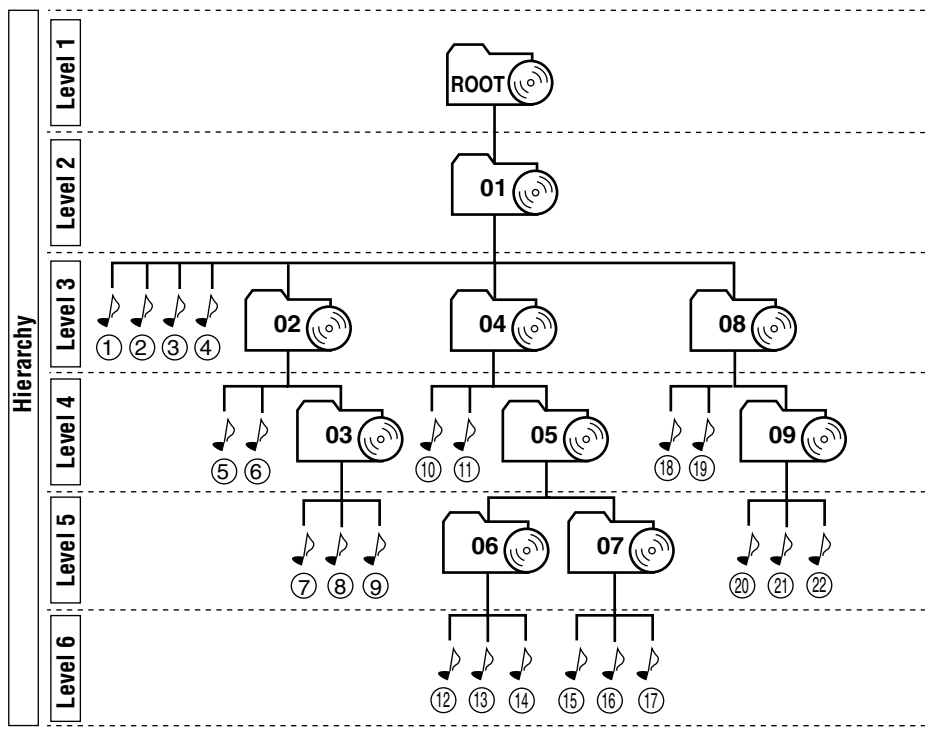
MP3 directory/file configuration



	: Root
	: Directories
	: MP3 files

Note:
 There is no limit on the number of the hierarchy levels (nested directories). However, up to 8 hierarchy levels is recommended for stable operations.

MP3 playback/search order

- The numbers in circles below the MP3 files (🎵) indicate the playback order and search order of the MP3 files. Normally this unit plays back MP3 files in the recorded order.
- The numbers inside the directories indicate the playback order and search order of the directories on an MP3 disc. Normally this unit plays back MP3 files in the directories in the recorded order.

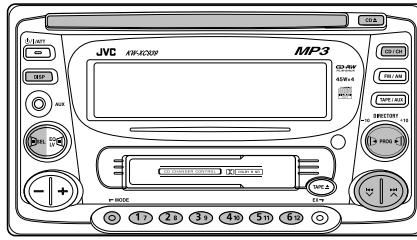

Refer also to “CD OPERATIONS” on pages 12 to 15.

Playing an MP3 disc

1 Insert an MP3 disc into the loading slot.

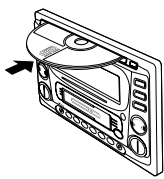

The unit turns on, draws in an MP3 disc and starts playback automatically.

Ex.: When the disc contains 13 directories and 125 MP3 files



Lights up

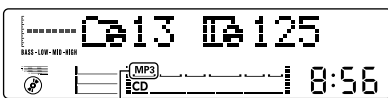

MP3 indicator lights up.

Playback starts automatically from the first file of the first directory once file check is completed. Then, the display changes to show the following:

- When “TAG ON” is selected (initial setting: see page 32)

Album name/performer name (directory name)* → Track title (file name)* → Elapsed playing time

- * If an MP3 file does not have ID3 tags, directory name and file name appear.

- When “TAG OFF” is selected
Directory name and file name appear.

Notes:

- All the files on the disc will be played repeatedly until you stop playback—All File Repeat Play.
- MP3 discs require a longer readout time**. (The readout time differs due to the complexity of the directory/file configuration.)

- ** Readout time is the time taken by the unit to scan or check the disc for files and file information.

To change the display information

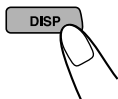

While playing back an MP3 file, you can change the file information shown on the display. Each time you press DISP (display), the display changes to show the following:

- When “TAG ON” is selected (initial setting: see page 32)

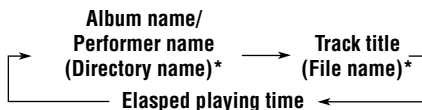

* If an MP3 file does not have ID3 tags, directory name and file name appear.

- When “TAG OFF” is selected



Notes:

- You can use the scroll mode to show the disc information on the display. See also “Selecting the scroll mode—SCROLL” on page 32.
- If you change the setting from “TAG OFF” to “TAG ON” while playing an MP3 file, the tag display will be activated when the next file starts playing.

To stop play and eject the disc

Press CD .

Disc play stops and the disc automatically ejects from the loading slot (“EJECT” appears on the display). The source changes to the last selected source.

If you change the source, the disc play also stops (without ejecting the disc this time).



Notes:

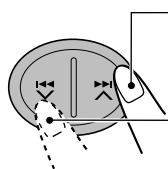

- If the ejected disc is not removed for about 15 seconds, the disc is automatically inserted again into the loading slot to protect it from dust. (Disc play will not start this time.)
- You can eject the disc even when the unit is turned off.

Locating a file or a particular portion on an MP3 disc

To fast-forward or reverse the file





Press and hold   while playing an MP3 disc, to fast-forward the file.

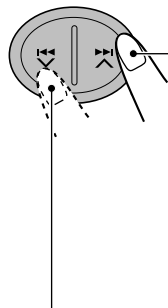

Press and hold   while playing an MP3 disc, to reverse the file.

To go to the next or previous files



Press   briefly while playing an MP3 disc, to go forward to the beginning of the next file.

Each time you press the button consecutively, the beginning of the next file is located and played back. (See “MP3 playback/search order” on page 17.)

Press   briefly while playing an MP3 disc, to go back to the beginning of the current file.

Each time you press the button consecutively, the beginning of the previous file is located and played back. (See “MP3 playback/search order” on page 17.)

To skip 10 files

MODE

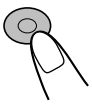

- 1 Press MODE repeatedly until “◀-10 +10▶” appears.

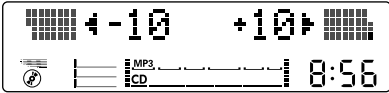
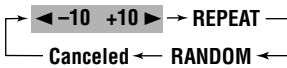

- 2 Press +10 or -10 button.

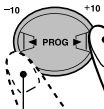

To skip 10 files* forwards to the last file

To skip 10 files* backwards to the first file

* The first time you press +10 or -10 button, the file skips to the nearest higher or lower file with a file number of multiple ten (ex. 10th, 20th, 30th).

Then each time you press the button, you can skip 10 files.

- After the last file, the first file will be selected, and vice versa.

To go to a particular directory directly

IMPORTANT:

To directly select the directories using the number button(s), it is required that directories are assigned 2 digit numbers at the beginning of their directory names. (This can only be done during the recording of CD-Rs or CD-RWs.)

Ex.: If directory name is “01 ABC”

→ press 1 to go to directory 01 ABC

If directory name is “1 ABC”

→ cannot directly select this directory.

If directory name is “12 ABC”

→ press and hold 6 (12) to go to directory 12 ABC

Press the number button corresponding to the directory number to start playing the first file in the selected directory.

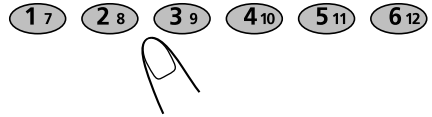

- To select a directory number from 1 – 6: Press 1 (7) – 6 (12) briefly.
- To select a directory number from 7 – 12: Press and hold 1 (7) – 6 (12) for more than 1 second.

Notes:

- If “MP3” flashes on the display after you have selected a directory, it means that the directory does not contain any MP3 files.
- You cannot directly select a directory with a number greater than 12.

To select a particular file in a directory, press ▶▶ ▲ or ◀◀ ▼ **after selecting the directory.**

To skip to the next directory or the previous directory—either on the same hierarchy level or on a different hierarchy level

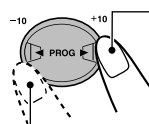

Press ▶ (+10) briefly while playing an MP3 disc.

Each time you press the button consecutively, the next directory is located (and the first file in the directory starts playing, if recorded).

(See “MP3 playback/search order” on page 17.)

Press ◀ (-10) briefly while playing an MP3 disc.

Each time you press the button consecutively, the previous directory is located (and the first file in the directory starts playing, if recorded).

(See “MP3 playback/search order” on page 17.)

Note:

If the directory does not contain any MP3 files, it is skipped.



Selecting MP3 playback modes

To play back tracks repeatedly (Repeat Play)

MODE



- 1 Press MODE repeatedly until "REPEAT" appears.

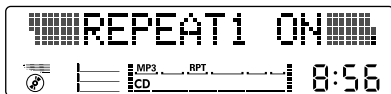
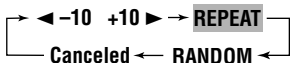

- 2 Press SEL (select). Each time you press the button, repeat play mode changes as follows:



Mode	RPT Indicator	Plays repeatedly
REPEAT1 ON	Lights	The current file (or specified file).
REPEAT2 ON	Flashes	All files of the current directory (or specified directory).
REPEAT OFF	Goes off	Canceled.

To play back tracks at random (Random Play)

MODE



- 1 Press MODE repeatedly until "RANDOM" appears.

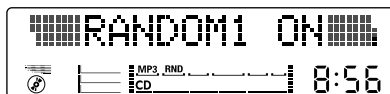
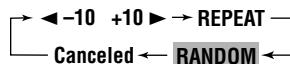

- 2 Press SEL (select). Each time you press the button, random play mode changes as follows:



Mode	RND Indicator	Plays at random
RANDOM1 ON	Lights	All files of the current directory, then the files of the next directory, and so on.
RANDOM2 ON	Flashes	All files of all directories.
RANDOM OFF	Goes off	Canceled.



TAPE OPERATIONS

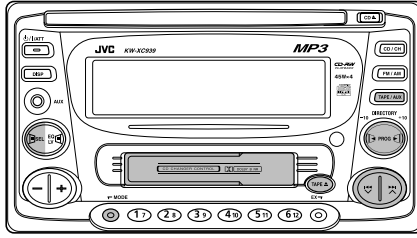

Listening to a tape

You can play back type I (normal) tapes.

1 Insert a cassette into the cassette compartment.

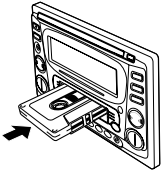

The unit turns on and tape play starts automatically. When one side of the tape reaches its end during play, the other side of the tape automatically starts playing. (Auto Reverse)



Tape indicator flashes

Note on One-Touch Operation:

When a cassette is already in the cassette compartment, pressing TAPE/AUX turns on the unit and starts tape play automatically.

2 Turn on or off the Dolby B NR* as needed.

MODE **1** Press MODE repeatedly until "DOLBY B" appears.



2 Press SEL (select). Each time you press the button, the Dolby B NR turns on ("DOLBY ON") and off ("DOLBY OFF").

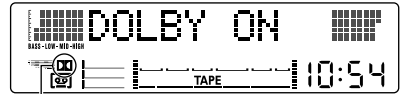

This indicator lights up when the Dolby B NR is turned on.

3 Select the tape direction.

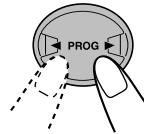

Each time you press the button, the tape direction changes alternately.

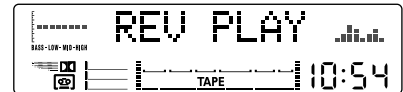
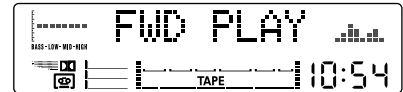

* Manufactured under license from Dolby Laboratories.

"Dolby" and the double-D symbol are trademarks of Dolby Laboratories.



To stop play and eject the cassette

Press TAPE ▲.

Tape play stops and the cassette automatically ejects from the cassette compartment.

If you change the source, the tape play also stops (without ejecting the cassette this time).

- You can also eject the cassette by pressing TAPE ▲ while the unit is turned off.

To fast-forward and rewind a tape

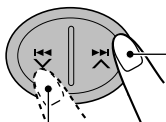

Press ►►► ▲ for more than 1 second to fast-forward the tape.

When the tape reaches its end, the tape is reversed and playback starts from the beginning of the other side.

Press ◀◀◀ ▼ for more than 1 second to rewind the tape. When the tape reaches its end, playback of the same side starts.

To stop fast-forward and rewind at any position on the tape, press ◀ PROG ▶.

Tape play starts from that position on the tape.

Note:

When the tape reaches its end while fast-forwarding, the tape direction will be changed automatically.

Finding the beginning of a tune

Multi Music Scan allows you to automatically start playback from the beginning of a specified tune. You can specify up to 9 tunes ahead of or before the current tune.

During playback

1 Specify where (how many tunes ahead of or before the current tune) the tune you want is located.

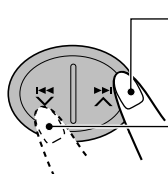

To locate a tune ahead of the current tune on the tape

To locate a tune before the current tune on the tape

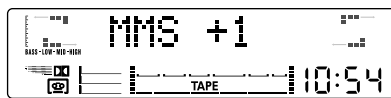

Each time you press the button, the number changes up to ±9.

When the beginning of the specified tune is located, playback starts automatically.

Notes:

- While locating a specified tune:
 - If the tape is rewound to its beginning, playback starts from the beginning of that side.
 - If the tape is fast-forwarded to the end, it is reversed and played from the beginning of the other side.
- In the following cases, Multi Music Scan may not operate correctly:
 - Tapes with tunes having long pianissimo passages (very quiet parts) or non-recorded portions.
 - Tapes with short non-recorded sections.
 - Tapes with high level noise or humming between tunes.
 - The Dolby NR setting does not match. For example, if the tape is recorded with the Dolby C NR.

Other convenient tape functions

Skipping blank portions on the tape

You can skip blank portions between the tunes (Blank Skip).

- MODE 1 Press MODE repeatedly until "B.SKIP" appears.

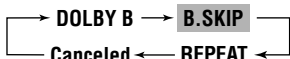

- SEL 2 Press SEL (select). Each time you press the button, skip function mode turns on ("B.SKIP ON") and off ("B.SKIP OFF") alternately.

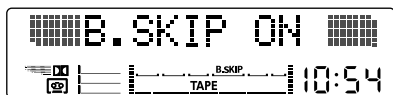

When this function is on, the B.SKIP indicator lights up on the display and the unit skips blank portions of 15 seconds or more, fast-forwards to the next tune, then starts playing it.

Playing the current tune repeatedly

You can play the current tune repeatedly (Repeat Play).

- MODE 1 Press MODE repeatedly until "REPEAT" appears.

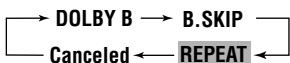

- SEL 2 Press SEL (select). Each time you press the button, repeat play mode turns on ("REPEAT ON") and off ("REPEAT OFF") alternately.



Notes:

In the following cases, Blank Skip and Repeat Play may not operate correctly:

- Tapes with tunes having long pianissimo passages (very quiet parts) or non-recorded portions.
- Tapes with short non-recorded sections.
- Tapes with high level noise or humming between tunes.
- The Dolby NR setting does not match. For example, if the tape is recorded with the Dolby C NR.

Prohibiting tape ejection

You can prohibit the tape ejection and can lock a tape in the cassette compartment.



While pressing TAPE/AUX, press and hold TAPE ▲ for more than 2 seconds. "TAPE ▲" flashes on the display for a while, and the tape is locked and cannot be ejected.



To cancel the prohibition and unlock the tape, press and hold TAPE ▲ for more than 2 seconds again, while pressing TAPE/AUX. "EJECT OK" flashes on the display for a while, and the tape is unlocked.



Adjusting the sound

You can adjust the sound characteristics to your preference.

1 Select the item you want to adjust.



Each time you press the button, the adjustable items change as follows:



Indication	To do:	Range
FADER*	Adjust the front and rear speaker balance.	R06 (Rear only) F06 (Front only)
BAL (Balance)	Adjust the left and right speaker balance.	L06 (Left only) R06 (Right only)
VOLUME	Adjust the volume.	00 (min.) 50 (max.)

* If you are using a two-speaker system, set the fader level to "00."

2 Adjust the level.

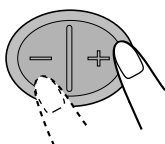

Note:

Normally + / - buttons work for volume adjustment. So you do not have to select "VOLUME" to adjust the volume level.

Reinforcing the bass sound

You can also adjust the level of Super Bass.

1 Select "S.BASS."

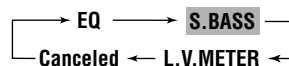

While adjusting Super Bass, S. BASS level flashes.



As the number increases, Super Bass level also increases.

2 Adjust the level within the range of "00" to "08."

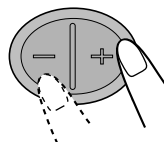



Selecting preset sound modes

You can select a preset sound adjustment suitable to the music genre.

1 Select "EQ."

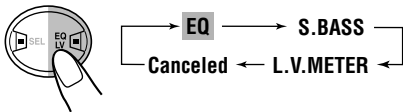

2 Select the sound mode.

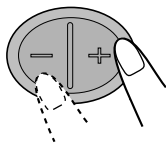

The sound mode changes as follows:

FLAT ↔ Hard Rock ↔ R & B* ↔
 POP ↔ JAZZ ↔ DanceMusic ↔
 Country ↔ Raggae ↔ Classic ↔
 USER** ↔ (back to the beginning)

* Rhythm and Blues

** If you want to adjust and store your original sound mode (USER), see "Storing your own sound adjustments" on page 27.

EQ level changes as you select the sound mode.

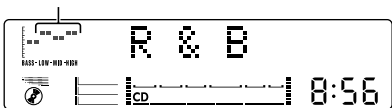

Ex.: When you select "R & B"

To cancel the sound mode, select "FLAT" in step 2.

Note:

You can adjust the sound mode to your preference, and store it in memory.

To store a sound mode separately for each playback source (EQ Link)

Once you select a sound mode, it is stored in memory. It will be recalled every time you select the same source. A sound mode can be stored for each of the following sources—FM1, FM2, FM3, AM, CD, tape, external components and the EX (extra) button (see page 10).

• See also "Changing general settings (PSM)" on page 30.

- 1 Press and hold SEL (select) for more than 2 seconds so that one of the PSM items appears on the display.
- 2 Press ►► ▲ or ◀◀ ▼ to select "EQ LINK (Equalization Link)."
- 3 Press + to select "LINK ON."
- 4 Press SEL (select) to finish the setting.

To cancel EQ Link, repeat the same procedure and select "LINK OFF" by pressing – in step 3.

- When "EQ LINK" is set to "LINK ON" The selected sound mode and Super Bass level can be stored in memory for the current source. Each time you select the same source, the same sound mode is also recalled, and shown after the source name.
- When "EQ LINK" is set to "LINK OFF" The selected sound mode effect applies to all the sources selected.

Storing your own sound adjustments

You can adjust the sound modes to your preference and store your own adjustments in memory (USER sound mode).

- There is a time limit in doing the following procedure. If the setting is cancelled before you finish, start from step **1** again.

1 Select "EQ."

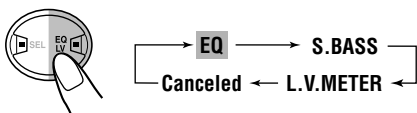

2 Select sound elements to adjust.

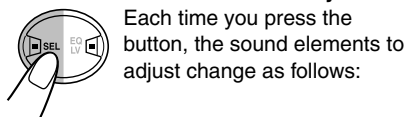

LOW FREQ.*	→	LOW LEVEL	→
MID FREQ.*	→	MID LEVEL	→
HIGH FREQ.*	→	HIGH LEVEL	→
(back to the beginning)			

FREQ. (LOW, MID, HIGH):

Select the center frequency to adjust.

LEVEL (LOW, MID, HIGH):

Adjust the enhancement level.

* By pressing **▶▶| ^** or **|◀◀ v**, you can directly move as follows:

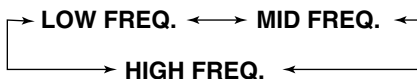

3 Adjust the selected sound element.

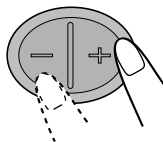

- Refer to the table below for adjusting the selected sound element.

Indication	Range
LOW FREQ.	50 Hz, 80 Hz, 120 Hz
LOW LEVEL	-06 (min.) — +06 (max.)
MID FREQ.	700 Hz, 1 kHz, 2 kHz
MID LEVEL	-06 (min.) — +06 (max.)
HIGH FREQ.	8 kHz, 12 kHz
HIGH LEVEL	-06 (min.) — +06 (max.)

EQ level adjusted flashes

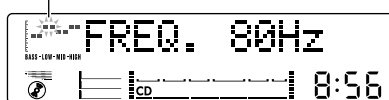

Ex.: When you adjust "LOW FREQ"

4 Repeat steps 2 and 3 to adjust the other sound elements.

5 Store the adjustments.



Your setting is stored in USER sound mode.

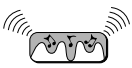

LEVEL METER SETTING

Selecting level meter patterns

You can select one from 7 different level meter patterns or a demonstration of all the patterns.

1 Select "L.V. METER."

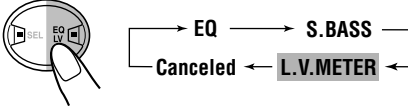

2 Press +/- to select the level meter pattern.

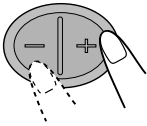

Each time you press the button, the level meter changes as follows:

ALL DEMO ↔ Standard ↔ SideWinder ↔
Full Size ↔ Spin ↔ Double ↔ HIGH WAY ↔
Dolphin ↔ OFF ↔ (back to the beginning)

Level meter patterns

1. ALL DEMO (initial setting)

Demonstrates all the level meter patterns, each for 20 seconds.

2. Standard

Standard level meter.



3. SideWinder

Level meter is displayed horizontally.



4. Full Size

Level meter is displayed on the main display.

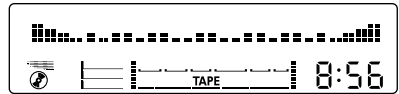

5. Spin

Spin in the right meter.



6. Double

Waves are displayed on both level meters.



7. HIGH WAY

As if you were driving along a highway.



8. Dolphin

A dolphin is swimming in the main display.



9. OFF

No level meter is displayed.

About the demonstration mode (DEMO MODE)

When shipped from the factory, "DEMO" is set to "DEMO ON" in this unit. The demonstration will start automatically if no sound comes in for 3 minutes. (See page 31.)

To deactivate the demonstration mode

- 1 Press and hold SEL (select) for more than 2 seconds so that one of the PSM items appears on the display. (See page 31.)



- 2 Press ►►| ^ or ◀◀| v to select "DEMO."

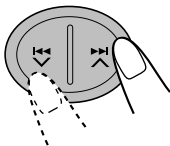

- 3 Press - to select "DEMO OFF."

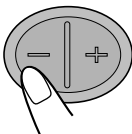

- 4 Finish the setting.



Setting the clock

After installation, set the built-in clock correctly.

- 1 Press and hold SEL (select) for more than 2 seconds so that one of the PSM items appears on the display. (See page 31.)



- 2 If "CLOCK HOUR" does not appear, press ►►| ^ or ◀◀| v repeatedly until it appears.

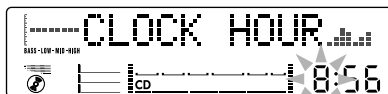
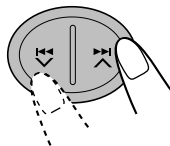

- 3 Adjust the hour.

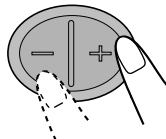

- 4 Press ►►| ^ or ◀◀| v until "CLOCK MIN" (minute) appears on the display.

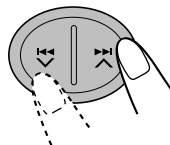

5 Adjust the minute.

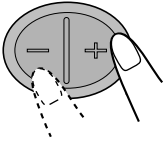

6 Finish the setting.



To check the current clock time while the unit is turned off, press DISP (display). The power turns on, the clock time is shown for 5 seconds, then the power turns off.

Changing general settings (PSM)

You can change the settings for this unit by using the PSM (Preferred Setting Mode) control.

Basic Procedure

- There is a time limit in doing the following procedure. If the setting is canceled before you finish, start from step **1** again.

1 Press and hold SEL (select) for more than 2 seconds so that one of the PSM items appears on the display. (See page 31.)



2 Select a PSM item you want to adjust. (See page 31.)

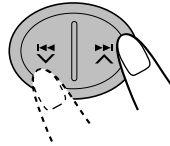

3 Adjust the PSM item selected.

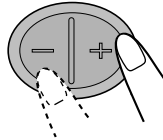

4 Repeat steps **2** and **3** to adjust the other PSM items if necessary.

5 Finish the setting.

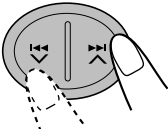
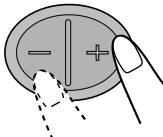

Preferred Setting Mode (PSM) items

		  		Factory-preset settings	See page
		-	+		
DEMO	Demonstration mode	DEMO OFF	DEMO ON	DEMO ON	31
CLOCK HOUR	Hour adjustment	Back	Advance	1:00	29
CLOCK MIN	Minute adjustment	Back	Advance		
CLOCK DISP	Clock display	CLOCK OFF	CLOCK ON	CLOCK OFF	31
EQ LINK	Sound control memory linkage	LINK ON	LINK OFF	LINK OFF	26
DIMMER	Dimmer mode	DIM OFF ↔ DIM ON ↕ DIM AUTO ↕		DIM AUTO	32
CONTRAST	Display contrast	CONTRAST 1 – CONTRAST 10		CONTRAST 5	32
SCROLL	Scroll mode	SCRL ONCE ↔ SCRL AUTO ↕ SCRL OFF ↕		SCRL ONCE	32
EXT INPUT	External input selection	CD CHANGER	LINE INPUT	CD CHANGER	32
AUX ADJ	Auxiliary input level adjustment	A.ADJ 00 – A.ADJ 05		A.ADJ 00	32
TAG DISP	Tag display	TAG OFF	TAG ON	TAG ON	32

Turning the demo mode on or off —DEMO MODE

You can turn the demo mode on or off. When shipped from the factory, "DEMO ON" is selected.

- DEMO OFF: Turns the demo mode off.
- DEMO ON: Turns the demo mode on. The demonstration will start automatically if no sound comes in for 3 minutes.

Note:

If the unit has been reset (and the power is on), the demonstration will start if no sound comes in for about 15 seconds.

Setting the clock display—CLOCK DISP

You can set the clock to show on the display when the unit is turned off.

When shipped from the factory, the clock is set not to show on the display.

- CLOCK OFF: Clock display is turned off.
- CLOCK ON: Clock display is turned on.

Note:

If the power supply is not interrupted by turning off the ignition key of your car, it is recommended to select "CLOCK OFF" to save the car's battery.

Selecting the dimmer mode—DIMMER

When you turn on the car headlights, the display automatically dims (Auto Dimmer).

When shipped from the factory, Auto Dimmer mode is activated.

- DIM OFF: Cancels Auto Dimmer.
- DIM ON: Always dims the display.
- DIM AUTO: Activates Auto Dimmer.

Note:

Auto Dimmer equipped for this unit may not work correctly on some vehicles, particularly on those having a control dial for dimming.

In this case, set the dimmer mode to "DIM ON" or "DIM OFF."

Adjusting the display contrast level—CONTRAST

You can adjust the display contrast level from 1 (dark) to 10 (bright).

When shipped from the factory, the display contrast level is set at level 5.

Selecting the scroll mode—SCROLL

You can select the scroll mode for the disc information.

When shipped from the factory, Auto Scroll mode is set to "SCRL ONCE."

- SCRL ONCE: Scrolls only once.
- SCRL AUTO: Repeats the scroll (5-second intervals in between).
- SCRL OFF: Cancels Auto Scroll.

Selecting the external component to use—EXT INPUT

You can connect an external component to the CD changer jack on the rear using the Line Input Adapter KS-U57 (not supplied).

To use the external component as the playback source through this unit, you need to select which component—CD changer or external component—to use.

When shipped from the factory, CD changer is selected as the external component.

- CD CHANGER: To use the CD changer.
- LINE INPUT: To use the external component other than CD changer.

Notes:

- *If the current source is CD changer or external component, this setting does not appear.*
- *For connecting the Line Input Adapter KS-U57 and the external component, refer to the Installation/Connection Manual (separate volume).*

Adjusting the auxiliary input level—AUX ADJ

Adjust the auxiliary input level properly when an external component is connected to the auxiliary input jack.

When shipped from the factory, the auxiliary (AUX) input level is set at level 00.

If the input level of the connected component is not high enough, increase the input level properly. Without adjusting the line input level, you may be surprised at the loud sound when you change source from the external component to another source.

Turning the tag display on or off—TAG DISP

An MP3 file can contain file information called "ID3 Tag" where its album name, performer, track title, etc. are recorded.

There are two versions—ID3v1 (ID3 Tag version 1) and ID3v2 (ID3 Tag version 2). This unit is compatible only with ID3v1.

When shipped from the factory, "TAG ON" is selected.

- TAG ON: Turns on the ID3 tag display while playing MP3 files.
 - If an MP3 file does not have ID3 tags, directory and file name appear.

Note:

If you change the setting from "TAG OFF" to "TAG ON" while playing an MP3 file, the tag display will be activated when the next file starts playing.

- TAG OFF: Turns off the ID3 tag display while playing MP3 files. (Only the directory name and file name can be shown.)

Assigning names to the sources

You can assign names to station frequencies, CDs, and the external component connected to the auxiliary (AUX) input jack.

After assigning a name, it will appear on the display when you select the source.

Sources	Maximum number of the characters
Station frequencies*	Up to 10 characters (up to 32 station frequencies including both FM and AM)
CDs** and CD changer**	Up to 32 characters (up to 40 discs)
External component ("AUX INPUT" only)	Up to 10 characters

* You cannot assign a name to a station frequency stored in the EX (extra) button.

** You cannot assign a name to a CD Text or an MP3 disc.

1 Select a source you want to assign a name to.

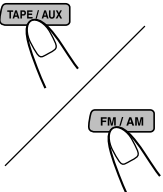

When you select a source, the power automatically comes on. Each time you press the button, the source changes as described on page 7.

2 Press and hold SEL (select) for more than 2 seconds while pressing DISP (display).

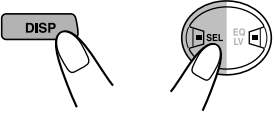

(at the same time)

3 Select the character set you want while "DISP" is flashing.

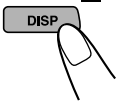

Each time you press the button, the character set changes as follows:

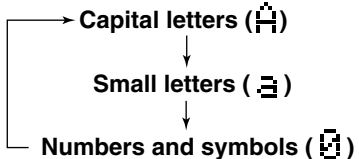

4 Select a character.

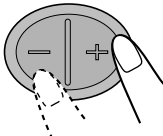

About the available characters, see page 38.

5 Move the cursor to the next (or previous) character position.

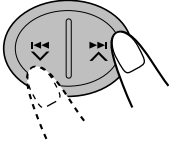

6 Repeat steps 3 to 5 until you finish inputting the name.

7 Finish the procedure while the last selected character is flashing.

To erase the input characters

To erase all the characters at a time, press and hold DISP (display) for more than 1 second as described in the procedure above.

Notes:

- When you try to assign a name to the 33rd station frequency or 41st CD, "NAME FULL" appears on the display. (In this case, delete unwanted names before assignment.)
- When the CD changer is connected, you can assign names to discs in the CD changer. These names can also be shown on the display if you insert the discs in this unit.



EXTERNAL COMPONENT OPERATIONS



MD player, etc.

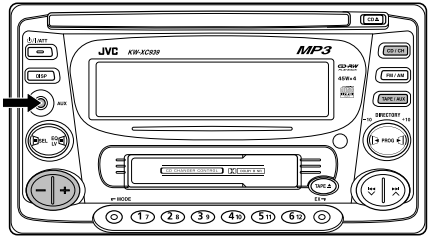

You can connect two external components to this unit.

Connect one to the auxiliary (AUX) input jack on the control panel, and the other to the CD changer jack on the rear.

2 Turn on the connected component and start playing the source.

3 Adjust the volume.

Preparations:

- For connecting the Line Input Adapter KS-U57 and the external component, refer to the Installation/Connection Manual (separate volume).
- Before operating the external component connected to the CD changer jack, select the external input correctly. (See “Selecting the external component to use—EXT INPUT” on page 32.)

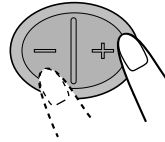

1 Select the external component.

AUX INPUT: Press TAPE/AUX repeatedly to select the component connected to the AUX jack on the control panel.



LINE INPUT: Press CD/CH repeatedly to select the component connected to the CD changer jack.

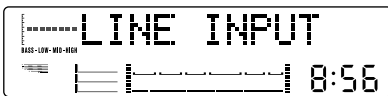

If the input level of the external component connected to the auxiliary (AUX) input jack is not high enough, increase the input level properly.

Without adjusting the input level, you may be surprised at the loud sound when you change the source from one external component to another. (See “Adjusting the auxiliary input level—AUX ADJ” on page 32.)

- If “LINE INPUT” does not appear on the display, see page 32 and select the external input (“Selecting the external component to use—EXT INPUT”).

CD CHANGER OPERATIONS

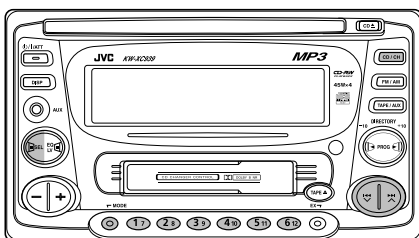

We recommend that you use one of the CH-X series with your unit (except for JVC MP3 compatible CD changer.)

If you have another CD automatic changer, consult your JVC IN-CAR ENTERTAINMENT dealer for connections.

- For Example, if your CD automatic changer is one of the KD-MK series, you need a cord (KS-U15K) for connecting it to this unit.

Note on One-Touch Operation:

When you press CD/CH, the power automatically comes on. You do not have to press **⏻ / ATT** to turn on the power.

Note:

If you play a CD with assigned name (see page 33), the assigned name appears on the display, followed by the track number and elapsed playing time.

Before operating your CD automatic changer:

- Refer also to the Instructions supplied with your CD changer.
- If no discs are in the magazine or the discs are inserted upside down, "NO DISC" will appear on the display. If this happens, remove the magazine and set the discs correctly.
- If "RESET 1" – "RESET 8" appears on the display, something is wrong with the connection between this unit and the CD changer. If this happens, check the connection, connect the connecting cord(s) firmly if necessary, then press the reset button of the CD changer.

To change the display information

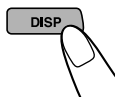

While playing back a CD, you can change the information shown on the display. Each time you press DISP (display), the display changes to show the following:

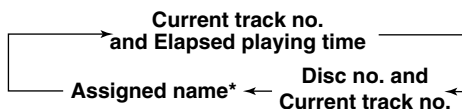

* If no name is assigned, "NO NAME" will appear.

Playing CDs

Select the CD automatic changer (CD-CH).



Playback starts from the first track of the first disc.
All tracks of all discs are played back.

Track number Elapsed playing time





To fast-forward or reverse the track

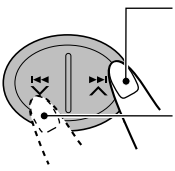

Press and hold **▶▶|▲** while playing a CD, to fast-forward the track.

Press and hold **|◀◀▼** while playing a CD, to reverse the track.

To go to the next or previous tracks

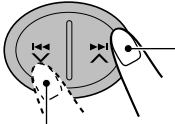

Press **▶▶|▲** briefly while playing a CD, to go ahead to the beginning of the next track. Each time you press the button consecutively, the beginning of the next tracks is located and played back.

Press **|◀◀▼** briefly while playing a CD, to go back to the beginning of the current track. Each time you press the button consecutively, the beginning of the previous tracks is located and played back.

To go to a particular disc directly

Press the number button corresponding to the disc number to start its playback (while CD changer is playing).

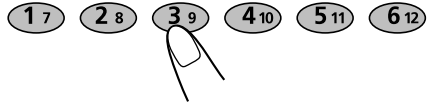

- To select a disc number from 1 – 6: Press 1 (7) – 6 (12) briefly.
- To select a disc number from 7 – 12: Press and hold 1 (7) – 6 (12) for more than 1 second.

Ex.: When disc number 3 is selected.

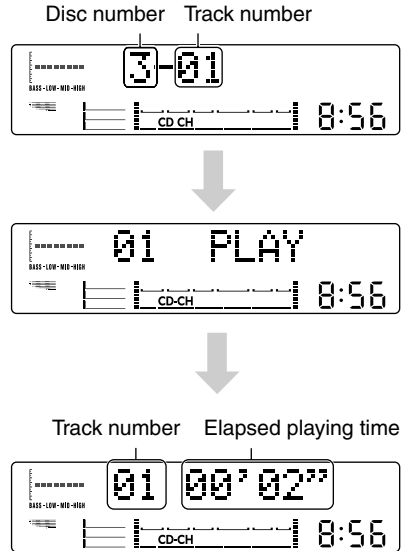

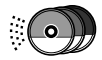

Selecting CD playback modes

To play back tracks repeatedly (Repeat Play)

MODE



- 1 Press MODE repeatedly until "REPEAT" appears.



- 2 Press SEL (select). Each time you press the button, CD repeat play mode changes as follows:



Mode	RPT Indicator	Plays repeatedly
REPEAT1 ON	Lights	The current track (or specified track).
REPEAT2 ON	Flashes	All tracks of the current disc (or specified disc).
REPEAT OFF	Goes off	Canceled.

To play back tracks at random (Random Play)

MODE



- 1 Press MODE repeatedly until "RANDOM" appears.



- 2 Press SEL (select). Each time you press the button, CD random play mode changes as follows:



Mode	RND Indicator	Plays at random
RANDOM1 ON	Lights	All tracks of the current disc, then the tracks of the next disc, and so on.
RANDOM2 ON	Flashes	All tracks of all discs inserted in the magazine.
RANDOM OFF	Goes off	Canceled.

To play back only intro (Intro scan)

MODE

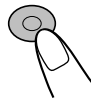

- 1 Press MODE repeatedly until "INTRO" appears.



- 2 Press SEL (select). Each time you press the button, CD intro scan mode changes as follows:



Mode	Indicator	Plays the beginnings (15 seconds)
INTRO1 ON	Track number flashes	Of all tracks on all inserted discs.
INTRO2 ON	Disc number flashes	Of the first track on each inserted disc.
INTRO OFF	None	Canceled.

Track number



Ex.: When "INTRO1 ON" is selected.

Disc number

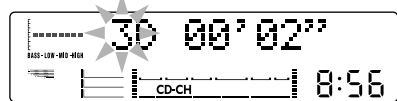

Ex.: When "INTRO2 ON" is selected.



ADDITIONAL INFORMATION

Available characters

- You can use the following characters to assign names to station frequencies, CDs, and external component. (See page 33.)
- You can display the information (album title, performer name, song title, etc.) as ID3v1 tags when you playback an MP3 file with this unit. (See pages 16 and 41.)

Capital letters

A	B	C	D	E
F	G	H	I	J
K	L	M	N	O
P	Q	R	S	T
U	V	W	X	Y
Z	space			

Small letters

a	b	c	d	e
f	g	h	i	j
k	l	m	n	o
p	q	r	s	t
u	v	w	x	y
z	space			

Numbers and symbols

0	1	2	3	4
5	6	7	8	9
!	”	#	\$	%
&	’	()	*
+	,	-	.	/
:	;	<	=	>
?	@	_	`	space

Handling cassettes

The cassette deck built in this unit requires very little attention, but you will be able to extend the life of the cassette deck if you follow the instructions in the column to the right.

To clean the heads

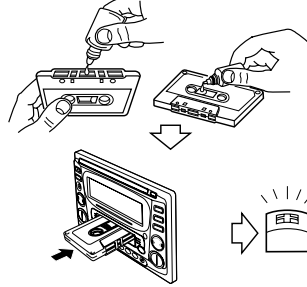

- Clean the heads after every 10 hours of use using a wet-type head cleaning tape (available at an audio store).
When the head becomes dirty, you may realize the following symptoms:
 - Sound quality is reduced.
 - Sound level decreases.
 - Sound drops out.
- Do not play dirty or dusty tapes.
- Do not touch the highly-polished head with any metallic or magnetic tools.

To keep the tape clean

- Always store the tapes in their storage cases after use.
- Do not store tapes in the following places:
 - Subject to direct sunlight
 - With high humidity
 - At extremely hot temperatures

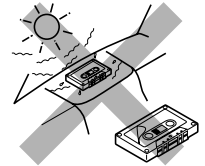

CAUTIONS:

- Do not play the tapes with peeling labels; otherwise, they can damage the unit.
- Tighten tapes to remove slack since loose tape may become entangled with the mechanism.
- Do not leave a cassette in the cassette compartment after use, as the tape may become slack.

The function below is also provided to ensure the longer life of the cassette deck.

Ignition key-off release

When you turn off the ignition key with a cassette in the compartment, the unit automatically releases the tape from its head.



Handling discs

This unit has been designed to reproduce CDs, CD-Rs (Recordable), CD-RWs (Rewritable), and CD Texts.

- This unit is also compatible with MP3 discs.

How to handle discs

When removing a disc from its case, press down the center holder of the case and lift the disc out, holding it by the edges.

Center holder

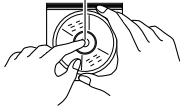

- Always hold the disc by the edges. Do not touch its recording surface.

When storing a disc into its case, gently insert the disc around the center holder (with the printed surface facing up).

- Make sure to store discs in their cases after use.

To keep discs clean

A dirty disc may not play correctly. If a disc does become dirty, wipe it with a soft cloth in a straight line from center to edge.



To play new discs

New discs may have some rough spots around the inner and outer edges.

If such a disc is used, this unit may reject the disc.

To remove these rough spots, rub the edges with a pencil or ball-point pen, etc.

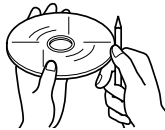

Moisture condensation

Moisture may condense on the lens inside the CD player in the following cases:

- After starting the heater in the car.
- If it becomes very humid inside the car.

Should this occur, the CD player may malfunction. In this case, eject the disc and leave the unit turned on for a few hours until the moisture evaporates.

When playing a CD-R or CD-RW

Before playing back CD-Rs or CD-RWs, read their instructions or cautions carefully.

- Use only “finalized” CD-Rs or CD-RWs.
- Some CD-Rs or CD-RWs may not play back on this unit because of their disc characteristics, and for the following reasons:
 - Discs are dirty or scratched.
 - Moisture condensation on the lens inside the unit.
 - The pickup lens inside the unit is dirty.
- CD-RWs may require a longer readout time since the reflectance of CD-RWs is lower than that of regular CDs.
- CD-Rs or CD-RWs are susceptible to high temperatures or high humidity, so do not leave them inside your car.
- Do not use following CD-Rs or CD-RWs:
 - Discs with stickers, labels, or protective seal stuck to the surface.
 - Discs on which labels can be directly printed by an ink jet printer.

Using these discs under high temperatures or high humidity may cause malfunctions or damage to discs. For example,

- Stickers or labels may shrink and warp a disc.
- Stickers or labels may peel off so discs cannot be ejected.
- Print on discs may get sticky.

Read instructions or cautions about labels and printable discs carefully.

CAUTIONS:

- Do not insert 8 cm discs (single CDs) into the loading slot. (Such discs cannot be ejected.)
- Do not insert any disc of unusual shape—like a heart or flower; otherwise, the unit will malfunction.
- Do not expose discs to direct sunlight or any heat source or place them in a place subject to high temperature and humidity. Do not leave them in a car.
- Do not use any solvent (for example, conventional record cleaner, spray, thinner, benzine, etc.) to clean discs.

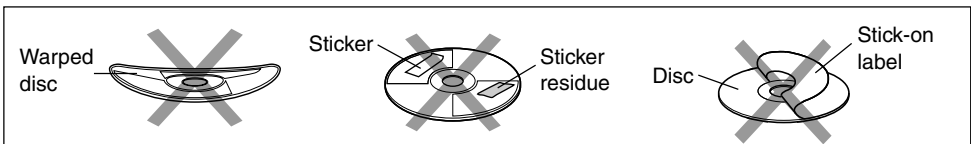



TROUBLESHOOTING

What appears to be trouble is not always serious. Check the following points before calling a service center.

	Symptoms	Causes	Remedies
General	• Sound is sometimes interrupted.	Connections are not good.	Check the cords and connections.
	• Sound cannot be heard from the speakers.	The volume control is turned to the minimum level.	Adjust it to the optimum level.
		Connections are incorrect.	Check the cords and connections.
	• This unit does not work at all.	The built-in microcomputer may have functioned incorrectly due to noise, etc.	Press the reset button on the front panel (see page 2.)
FM/AM	• SSM (Strong-station Sequential Memory) automatic preset does not work.	Signals are too weak.	Store stations manually.
	• Static noise while listening to the radio.	The aerial is not connected firmly.	Connect the aerial firmly.
Disc Playback	• Disc cannot be played back. • Disc sound is sometimes interrupted.	Disc is inserted upside down.	Insert the disc correctly.
		You are driving on rough roads.	Stop disc play while driving on rough roads.
		Disc is scratched.	Change the disc.
	• “NO DISC” appears on the display.	Connections are incorrect.	Check the cords and connections.
		No disc is in the loading slot (or in the magazine.)	Insert a disc into the loading slot.
	• Disc can neither be played back nor ejected.	Disc is inserted incorrectly.	Insert the disc correctly.
		The CD player may be functioning incorrectly.	Press and hold both the ⏏/ATT and CD ▲ buttons at the same time for several seconds.
	• “EJECT ERR” appears on the display.	The disc was interrupted ejection or insertion.	Press CD ▲ , or press both the ⏏/ATT and CD ▲ buttons together to clear the message.
• CD-R/CD-RW cannot be played back. • Tracks on the CD-R/CD-RW cannot be skipped.	CD-R/CD-RW is not finalized.	<ul style="list-style-type: none"> • Insert a finalized CD-R/CD-RW. • Finalize the CD-R/CD-RW with the component which you used for recording. 	



Symptoms	Causes	Remedies
<ul style="list-style-type: none"> • Disc cannot be played back. 	No MP3 files are recorded on the disc.	Change the disc.
	MP3 files do not have the extension code—mp3 in their file names.	Add the extension code —mp3 to their file names.
	MP3 files are not recorded in the format compliant with ISO 9660 Level 1 or 2.	Change the disc. (Record MP3 files using a compliant application.)
<ul style="list-style-type: none"> • Files skip, or 00'00" appears and playback stops. 	Files are encoded in Layer 1 or Layer 2 format.	Insert a disc that contains files encoded in Layer 3 format.
<ul style="list-style-type: none"> • Noise is generated. 	The file played back is not an MP3 file (although it has the extension code—mp3).	Skip to another file or change the disc. (Do not add the extension code—mp3 to non-MP3 files.)
<ul style="list-style-type: none"> • A longer readout time is required ("FILE CHECK" keeps flashing on the display). 	Readout time varies due to the complexity of the directory/file configuration.	Do not use too many hierarchies and directories. Also, do not record any other types of audio tracks together with MP3 files.
<ul style="list-style-type: none"> • Files cannot be played back as you have intended them to play. 	Playback order is determined when the files are recorded.	_____
<ul style="list-style-type: none"> • Elapsed playing time is not correct. 	This sometimes occurs during play. This is caused by how the files are recorded on the disc.	_____
<ul style="list-style-type: none"> • "MP3" flashes on the display. 	There are no MP3 files in the current directory.	Select another directory.
<ul style="list-style-type: none"> • "NO FILES" appears on the display for a while, then the disc ejects automatically. 	There are no MP3 files in this disc.	Insert a disc that contains MP3 files.
<ul style="list-style-type: none"> • Correct characters are not displayed. (Tag Display, e.g. album name) 	This unit can only display alphabet (capital: A–Z, small: a–z) and numbers.	_____

MP3 Playback



	Symptoms	Causes	Remedies
Tape Playback	• A cassette tape cannot be inserted.	You have tried to insert a cassette in the wrong way.	Insert the cassette with the exposed tape facing right.
	• Cassette tapes become hot.	This is not a malfunction.	_____
	• Tape sound is at very low level and sound quality is degraded.	The tape head is dirty.	Clean it with a head cleaning tape.
CD Changer	• “NO MAGAZINE” appears on the display.	No magazine is loaded in the CD changer.	Insert the magazine.
	• “RESET 8” appears on the display.	This unit is not connected to a CD changer correctly.	Connect this unit and the CD changer correctly and press the reset button of the CD changer.
	• “RESET 1” – “RESET 7” appears on the display.	_____	Press the reset button of the CD changer.
	• The CD changer does not work at all.	The built-in microcomputer may function incorrectly due to noise, etc.	Press the reset button on the front panel (see page 2.)

About mistracking:

Mistracking may result from driving on extremely rough roads. This does not damage the unit and the CD, but will be annoying. We recommend that you stop CD play while driving on such rough roads.

AUDIO AMPLIFIER SECTION

Maximum Power Output:

Front: 45 W per channel

Rear: 45 W per channel

Continuous Power Output (RMS):

Front: 17 W per channel into 4 Ω ,
40 Hz to 20 000 Hz at no more
than 0.8% total harmonic
distortion.

Rear: 17 W per channel into 4 Ω ,
40 Hz to 20 000 Hz at no more
than 0.8% total harmonic
distortion.

Load Impedance: 4 Ω (4 to 8 Ω allowance)

Equalizer Control Range:

LOW: ± 12 dB (50 Hz, 80 Hz, 120 Hz)

MID: ± 12 dB (700 Hz, 1 kHz, 2 kHz)

HIGH: ± 12 dB (8 kHz, 12 kHz)

Frequency Response: 40 Hz to 20 000 Hz

Signal-to-Noise Ratio: 70 dB

Auxiliary input jack: 3.5 mm dia. stereo mini jack

Line-Out Level/Impedance:

2.0 V/20 k Ω load (full scale)

Output Impedance: 1 k Ω

TUNER SECTION

Frequency Range:

FM: 87.5 MHz to 108.0 MHz

AM: 531 kHz to 1 602 kHz

[FM Tuner]

Usable Sensitivity: 11.3 dBf (1.0 μ V/75 Ω)

50 dB Quietening Sensitivity:

16.3 dBf (1.8 μ V/75 Ω)

Alternate Channel Selectivity (400 kHz):

65 dB

Frequency Response: 40 Hz to 15 000 Hz

Stereo Separation: 35 dB

Capture Ratio: 1.5 dB

[AM Tuner]

Sensitivity: 20 μ V

Selectivity: 35 dB

CD PLAYER SECTION

Type: Compact disc player

Signal Detection System: Non-contact optical pickup (semiconductor laser)

Number of channels: 2 channels (stereo)

Frequency Response: 5 Hz to 20 000 Hz

Dynamic Range: 96 dB

Signal-to-Noise Ratio: 98 dB

Wow and Flutter: Less than measurable limit

MP3 decoding format: MPEG1/2 Audio Layer 3

Max. Bit Rate: 320 Kbps

CASSETTE DECK SECTION

Wow and Flutter: 0.1 % (WRMS)

Fast-Wind Time: 100 sec. (C-60)

Frequency Response: 30 Hz to 16 000 Hz
(Normal tape)

Signal-to-Noise Ratio: (Normal tape)

Dolby B NR ON: 65 dB

Dolby B NR OFF: 56 dB

Stereo Separation: 40 dB

GENERAL

Power Requirement:

Operating Voltage: DC 14.4 V

(11 V to 16 V allowance)

Grounding System: Negative ground

Allowable Operating Temperature:

0°C to +40°C

Dimensions (W x H x D):

Installation Size:

178 mm x 100 mm x 150 mm

Front Panel Size:

170 mm x 96 mm x 20 mm

Mass: 2.2 kg (excluding accessories)

Design and specifications are subject to change without notice.



**Having TROUBLE with operation?
Please reset your unit**

Refer to page of How to reset your unit

**Затруднения при эксплуатации?
Пожалуйста, перезагрузите Ваше
устройство**

Для получения информации о перезагрузке Вашего устройства обратитесь на соответствующую страницу

JVC

VICTOR COMPANY OF JAPAN, LIMITED



EN, RU

© 2003 VICTOR COMPANY OF JAPAN, LIMITED



0603MNMMDWJEIN

ENGLISH

Questions and Answers — Music File MP3

This sheet is provided for MP3 compatible CD changers and receivers.

Q1 What is MP3?

MP3, so-called "MPEG Audio Layer 3," is one of digital compression standards for specifying the audio part of moving-picture compression standard "MPEG." MP3 can compress music data to about one-tenth of the original size. Compared with conventional CDs which can only record up to 74 minutes worth of music data, if you write MP3 files to 650 MB CD-Rs/RWs, music data worth of about 10 CDs can be stored on a disc (at a bit rate of 128 Kbps).

Q2 What type of MP3 files can be played back on this player?

MP3 files placed on CD media (CD-ROM, CD-R or CD-RW) can be played back. When creating MP3 discs using your computer, CD-R/RW drive and writing software, you have to observe the following precautions:

- When writing MP3 files to CD media, you are recommended to use Joliet, ISO 9660 Level 1, or ISO 9660 Level 2 as your CD format. With any other file formats, folder/file names may not be correctly displayed.
- Be sure to add a file extension [.MP3] to any MP3 files. This player cannot play back files with no extension [.MP3] even if they are actually MP3 files. Furthermore, files created in non-MP3 format cannot properly be played back even if they have file extensions [.MP3] in their file names.
- This player is not compatible with the data encoded with Layer 1 and 2 formats.

Q3 Is there any limit on the number of folders and files?

This player can handle a maximum of 289* folders and files. If a disc includes more than the maximum, this player cannot handle surplus folders and files. Folders with no MP3 files included and files with no extension [.MP3] are disregarded.

- This player has such a feature that allows you to repeatedly play back the files in a desired folder or randomly play back the files from a disc. So, when creating MP3 discs, if you make folders by artist or album and insert the related MP3 files into them, you can realize such convenience in use as you would experience with a CD changer.

* This number is for a CD receiver. For a CD changer, the maximum number is 512.

Q4 Can MP3 discs with many hierarchy levels be played back?

There is no limit on the number of the hierarchy levels. However, up to 8 hierarchy levels is recommended for stable operations.

Q5 Can 80-minute discs (capacity: 700 MB) be utilized?

Yes, they can (but not for the discs of any longer time than 80 minutes).

Q6 Can CD-Rs/RWs including both music CD data (CD-DA) and MP3 data be played back?

Only data of the first recognized type is played back.

Q7 Can CD-Rs/RWs with MP3 data added later (multi-session discs) be played back?

Yes, they can.

- Be sure to perform "session close" on such discs; otherwise, an unclosed session cannot be detected and cannot be played back.

Q8 Is this player compatible with "Emphasis"?

Yes, it is.

Q9 What sampling frequency range can be handled?

A sampling frequency range of 16 kHz – 48 kHz can be handled.

MPEG1	48 kHz	44.1 kHz	32 kHz
MPEG2	24 kHz	22.05 kHz	16 kHz

But depending on the type of the encoder used, playback may not take place correctly.

РУССКИЙ

Вопросы и ответы – Музыкальный файл MP3

Данная брошюра поставляется с MP3-совместимыми проигрывателями компакт-дисков и принимающими устройствами.

В. 1 Что такое MP3?

MP3, так называемый "Звуковой слой 3 MPEG," представляет собой один из стандартов цифрового уплотнения, предназначенный для обозначения звуковой части стандарта сжатия киноизображения "MPEG." MP3 может уплотнять музыкальные данные до примерно одной десятой первоначального размера. По сравнению с традиционными компакт-дисками, на которые можно записывать только до 74 минут музыкальных данных, при записи файлов MP3 на компакт-диски однократной записи и перезаписываемые компакт-диски на 650 мегабайт на одном диске можно записать музыкальные данные в объеме, равном примерно 10 компакт-дискам (при скорости передачи битов 128 Кбит/с).

В. 2 Какой тип файлов MP3 можно воспроизводить на данном проигрывателе?

Можно воспроизводить файлы MP3, записанные на различные компакт-диски (компакт-диск постоянной памяти, компакт-диск однократной записи или перезаписываемый компакт-диск). При создании дисков MP3 с помощью Вашего компьютера, дисковода компакт-дисков однократной записи/ перезаписываемых компакт-дисков и программного обеспечения для записи Вы должны соблюдать следующие меры предосторожности:

- При записи файлов MP3 на компакт-диск Вам рекомендуется использовать Joliet, уровень 1 ISO 9660 или уровень 2 ISO 9660 в качестве формата Вашего компакт-диска. В любых других форматах файлов названия папок/файлов могут быть показаны неправильно.
- Не забудьте добавить расширение имени файла [.MP3] к любым файлам MP3. Данный проигрыватель не может воспроизводить файлы без расширения имени [.MP3], даже если они действительно являются файлами MP3. Более того, файлы, созданные не в формате MP3, невозможно правильно воспроизводить, даже если они имеют расширение имени файла [.MP3] в своих названиях файлов.
- Данный проигрыватель не совместим с данными, закодированными в форматах слоя 1 и 2.

В. 3 Имеется ли какое-либо ограничение по количеству папок и файлов?

Данный проигрыватель может обработать максимум 289* папок и файлов. Если на диске записано больше этого максимума, данный проигрыватель не может обработать излишнее количество папок и файлов. Папок, в которые не включены файлы MP3, и файлы без расширения имени файла [.MP3] игнорируются.

- Данный проигрыватель обладает такой функциональной возможностью, которая позволяет Вам повторно воспроизводить файлы в желаемой папке или воспроизводить в произвольном порядке файлы на диске. Таким образом, при создании дисков MP3, если Вы делаете папка по артисту или альбому и вставляете туда относящиеся к этому файлы MP3, Вы можете добиться такого же удобства при пользовании, которое Вы имеете, когда пользуетесь проигрывателем-автоматом компакт-дисков.

* Это число относится к принимающему устройству компакт-дисков. Для проигрывателя компакт-дисков максимальным числом является 512.

В. 4 Можно ли воспроизводить диски MP3 со многими уровнями иерархии?

Не существует ограничения по количеству уровней иерархии. Однако, для стабильной работы рекомендуется использовать до 8 уровней иерархии.

В. 5 Можно ли использовать 80-минутные диски (емкость: 700 Мбайт)?

Да, можно (но не диски на более чем 80 минут).

В. 6 Можно ли воспроизводить компакт-диски однократной записи и перезаписываемые компакт-диски, включающие данные музыкальных компакт-дисков (CD-DA) и данные MP3?

Воспроизводятся только данные первого распознанного типа.

В. 7 Можно ли воспроизводить компакт-диски однократной записи и перезаписываемые компакт-диски, на которые данные MP3 были добавлены позднее (многосеансовые диски)?

Да, можно.

- Нужно обязательно выполнять "сеанс закрыт" на таких дисках, иначе незакрытые сеансы нельзя будет обнаружить и нельзя будет воспроизвести.

В. 8 Совместим ли данный проигрыватель с "Emphasis"?

Да, совместим.

В. 9 Какой диапазон частот дискретизации может быть обработан?

Может быть обработан диапазон частот дискретизации 16 кГц – 48 кГц.

MPEG1	48 кГц	44,1 кГц	32 кГц
MPEG2	24 кГц	22,05 кГц	16 кГц

Но в зависимости от типа применяемого кодирующего устройства воспроизведение может происходить неправильно.

Q10 Is there any bit-rate related constraint on MP3 file playback?

There is no particular constraint, but you are recommended to use a stereo with a bit rate of 128 Kbps or over in terms of sound quality. This player can also handle VBR (variable bit rate).

Q11 Is the player compatible with M3U playlist?

No, it isn't.

Q12 Is the player compatible with ID3 Tag?

It is compatible with ID3 Tag Version 1. But be careful as the player isn't compatible with Version 2. The one-byte letters, numbers and symbols listed below can be recognized (except for some models).

- For more precise information on the available characters, see the Instructions supplied.

Capital letters					Small letters					Numbers and symbols				
A	B	C	D	E	a	b	c	d	e	0	1	2	3	4
F	G	H	I	J	f	g	h	i	j	5	6	7	8	9
K	L	M	N	O	k	l	m	n	o	!	"	#	\$	%
P	Q	R	S	T	p	q	r	s	t	&	'	()	*
U	V	W	X	Y	u	v	w	x	y	+	,	-	.	/
Z	Space				z	Space				:	;	<	=	>
										?	@	_	`	Space

Q13 MP3 folder/file names displayed are different from those given at the time of MP3 disc creation (names displayed on computers)...?

With this player, folder/file names are displayed as follows:

- Folder/file names can be displayed by scrolling, if necessary.
- This player is compatible with Joliet, ISO 9660 Level 1, ISO 9660 Level 2, and Romeo folder/file names. (Up to 128* character will be displayed for Romeo format.)
- This player can handle only one-byte characters. Any other characters cannot be correctly displayed.

* When operating a CD changer, this maximum number decreases to 64 for a disc including more than 290 folder and files in total.

Q14 MP3 files cannot be played back...?

Playback is **not possible** in the following cases:

- The "Packet Write" method is used to record on CD-Rs/RWs.
- The file extension is not [.MP3].
- The file encoded with Layer 1 or Layer 2 (even if extension is [.MP3]).
- The file data is not in MP3 data format.
- Playback may not be possible, depending on recording conditions (data missing, etc.) or media conditions (stain, scratch, warp, etc.).

Q15 An MP3 disc requires a long readout time...?

When an MP3 disc is inserted, information inside the disc (number of folders and files, and positions of data) is first read.

So, in the following cases, a fairly long time may be needed before playback starts:

- If the file structure is complicated,
- If the number of files is large, or
- If the number of sessions is large (in case of multi-session discs).

Q16 There occurs sound interruption or sound skipping...?

Sound interruption or sound skipping may occur, depending on recording conditions (missing data, etc.) or media conditions (stain, scratch, warp, etc.).

Q17 Can WAV files be played back?

No, they can't. WAV files cannot be handled.

Q18 Can such compression formats as WMA and ATRACK 3 be played back?

No, they can't.

Q19 MP3 files are not played back in an intended order...?

The playback order of MP3 files may differ from your intended order since your writing software may rearrange the order of folders and files when writing to CD-Rs/RWs.

Q20 Are there any functions restrained during MP3 playback?

- The search function works but search speed is not constant during search.
- When skip is tried at the last file in a folder, the next folder is selected.

Q21 Elapsed playing time is not displayed correctly...?

Files recorded in VBR (variable bit rate) have a discrepancy in elapsed time display, and do not show the actual passage of time. Especially, after performing the search function, this difference becomes noticeable.

B. 10 Есть ли какое-либо связанное со скоростью передачи битов ограничение при воспроизведении файлов MP3?

Какого-либо конкретного ограничения нет, но Вам рекомендуется использовать стерео со скоростью передачи битов 128 Кбит/с или более в отношении качества звука. Данный проигрыватель может также обрабатывать VBR (переменный поток данных).

B. 11 Совместим ли данный проигрыватель со списком воспроизведения M3U?

Нет, не совместим.

B. 12 Совместим ли данный проигрыватель с тегом ID3?

Он совместим с тегом ID3, вариант 1. Но необходимо соблюдать осторожность, поскольку данный проигрыватель не совместим с вариантом 2. Однобайтные буквы, числа и символы, перечисленные ниже, могут распознаваться (за исключением некоторых моделей).

- Более точную информацию относительно имеющихся знаков смотрите в прилагаемых Инструкциях.

Заглавные буквы					Строчные буквы					Числа и символы				
A	B	C	D	E	a	b	c	d	e	0	1	2	3	4
F	G	H	I	J	f	g	h	i	j	5	6	7	8	9
K	L	M	N	O	k	l	m	n	o	!	"	#	\$	%
P	Q	R	S	T	p	q	r	s	t	&	'	()	*
U	V	W	X	Y	u	v	w	x	y	+	,	-	.	/
Z	Промежуток				z	Промежуток				:	;	<	=	>
										?	@	_	`	Промежуток

B. 13 Отличаются ли показываемые на экране дисплея названия папок/файлов MP3 от тех, которые даны во время создания диска MP3 (названия, показываемые на компьютерах)...?

С данным проигрывателем названия папок/файлов на экране дисплея показываются следующим образом:

- Названия папок/файлов могут показываться на экране дисплея путем прокрутки, если требуется.
- Данный проигрыватель совместим с названиями папок/файлов Joliet, ISO 9660 уровня 1, ISO 9660 уровня 2 и Romeo. (В формате Romeo на экране дисплея будет показано до 128* знаков.)
- Данный проигрыватель может обрабатывать только однобайтные знаки. Любые другие знаки невозможно правильно изобразить на экране дисплея.

* При работе проигрывателя компакт-дисков это максимальное число снижается до 64 для диска, включающего в общей сложности более 290 папок и файлов.

B. 14 Файлы MP3 невозможно воспроизводить...?

Воспроизведение **невозможно** в следующих случаях:

- Для записи на компакт-дисках однократной записи и перезаписываемых компакт-дисках используется метод "Packet Write" ["пакетная запись"].
- Расширение имени файла - не [.MP3].
- Файл закодирован со слоем 1 или слоем 2 (даже если расширение имени - [.MP3]).
- Данные файла записаны не в формате данных MP3.
- Воспроизведение невозможно, в зависимости от условий записи (отсутствуют данные и т.п.) или состояния носителя (пятно, царапина, деформация и т.п.).

B. 15 Диск MP3 требует длительного времени считывания?

Когда вставлен диск MP3, сначала считывается информация внутри такого диска (количество папок и файлов, а также местоположение данных).

Таким образом, в следующих случаях может пройти довольно длительное время до того, как начнется воспроизведение:

- Если структура файла является сложной,
- Если количество файлов большое, или
- Если имеется большое количество сеансов (в случае многосеансовых дисков).

B. 16 Имеют ли место случаи перерыва или пропуска звука?

Перерывы звука или пропуски звука могут случаться, в зависимости от условий записи (отсутствуют данные и т.п.) или состояния носителя (пятно, царапина, деформация и т.п.).

B. 17 Можно ли воспроизводить файлы WAV (звуковые файлы)?

Нет, нельзя. Файлы WAV не могут быть обработаны.

B. 18 Могут ли воспроизводиться такие форматы сжатия, как WMA и ATRACK 3?

Нет, не могут.

B. 19 Файлы MP3 не воспроизводятся в запланированном порядке...?

Порядок воспроизведения файлов MP3 может отличаться от запланированного Вами порядка, поскольку используемое Вами программное обеспечение записи может переделать порядок папок и файлов при записи на компакт-дисках однократной записи и перезаписываемых компакт-дисках.

B. 20 Ограничивается ли действие каких-либо функций во время воспроизведения MP3?

- Функция поиска работает, но скорость поиска непостоянна во время поиска.
- При попытке перейти на последний файл в какой-либо папке выбирается следующая папка.

B. 21 Истекшее время воспроизведение не показывается правильно на экране дисплея...?

Файлы, записанные в VBR (переменный поток данных), имеют расхождение в показе на экране дисплея истекшего времени и не показывают фактически прошедшее время. Эта разница становится особенно заметной после выполнения функции поиска.

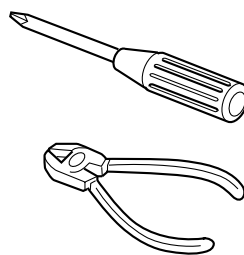

ENGLISH

- This unit is designed to operate on 12 V DC, NEGATIVE ground electrical systems.

INSTALLATION (IN-DASH MOUNTING)

The following illustration shows a typical installation. However, you should make adjustments corresponding to your specific car. In this case consult the manual included with the installation kit (option).

In some case, depending of the type and the model of your car, it is not possible to install the unit into the center console.

If you have any questions or require information regarding installation kits, consult your JVC IN-CAR ENTERTAINMENT dealer or a company supplying kits.

Before installing the unit

- To prevent short circuits, it is recommended to disconnect the battery's negative terminal and make all electrical connections before installing the unit.
- For reason of security, do not install the unit in a place where it may disturb your driving or where there is not enough ventilation space around the unit.
- When the installation position has been determined, confirm that the cords are sufficiently long.
- When mounting the unit, be sure to use the screws provided, as instructed. If other screws are used, there is a possibility that parts could become loose or damaged.
- If you are not sure how to install this unit correctly, consult a JVC IN-CAR ENTERTAINMENT dealer or have it installed by a qualified technician.
- When tightening screws or bolts be careful not to pinch any connection cord.

Caution:

To install the mounting brackets to the unit, use only the supplied screws (M5 x 6 mm). If you use any screw longer than 6 mm, the unit can be damaged.

After installing the unit

Check if all the brake lamps, lights, flasher, wiper, etc. work correctly.

РУССКИЙ

- Это устройство разработано для эксплуатации на 12 В постоянного напряжения с минусом на массе.

УСТАНОВКА (УСТАНОВКА В ПРИБОРНУЮ ПАНЕЛЬ)

На следующей иллюстрации показана типовая установка. Однако возможны дополнительные регулировки в соответствии с определенным автомобилем. В этом случае обратитесь к руководству, включенному в монтажный комплект (поставляется отдельно). В некоторых случаях, в зависимости от типа и модели автомобиля, устройство можно установить на центральной панели.

При появлении вопросов или при необходимости получения информации относительно монтажных комплектов обратитесь к поставщику автомобильных аудиосистем компании JVC IN-CAR ENTERTAINMENT или в компанию, поставляющую монтажные комплекты.

Перед установкой устройства

- Для предотвращения коротких замыканий рекомендуется отключить отрицательный терминал аккумуляторной батареи и выполнить все электрические соединения перед установкой устройства.
- В целях безопасности не устанавливайте данное устройство в местах, где оно может помешать вождению или в местах с недостаточной вентиляцией.
- После определения места установки проверьте, достаточна ли длина кабелей.
- При установке устройства используйте только прилагаемые болты в соответствии с инструкцией. В случае использования других болтов существует вероятность, что детали могут быть потеряны или повреждены.
- Если нет уверенности в том, как правильно установить устройство, обратитесь за консультацией к поставщику автомобильных аудиосистем компании JVC IN-CAR ENTERTAINMENT или к квалифицированному техническому специалисту.
- Аккуратно затягивайте болты, чтобы не пережать соединительные кабели.

Внимание:

Для прикрепления крепежных скоб к устройству используйте только прилагаемые болты (M5 x 6 мм). Использование любых болтов длиной более 6 мм может привести к повреждению устройства.

После установки устройства

Убедитесь, что стоп-сигналы, фары, поворотники, дворники и т.п. устройства работают корректно.

Parts list for installation and connection

The following parts are provided with this unit.
After checking them, please set them correctly.

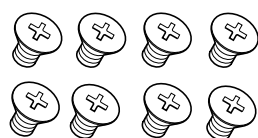

Flat countersunk screws (M5 x 6 mm)
Болты с плоской потайной головкой (M5 x 6 мм)

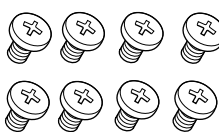

Binding screws (M5 x 6 mm)
Зажимные болты (M5 x 6 мм)

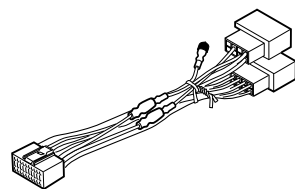

Power cord
Кабель питания

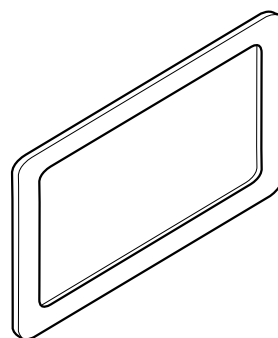
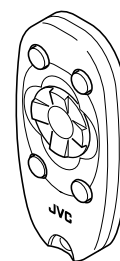

Plate for use with a Nissan car
Пластина для автомобилей марки Nissan



CR2025

Batteries
Батарейка



Remote controller
дистанционного управления

Список деталей для установки и подключения

Следующие детали поставлены в комплекте с устройством.
После проверки комплектации, пожалуйста, установите их правильно.

TROUBLESHOOTING

• The fuse blows.

- * Are the red and black leads connected correctly?

• Power cannot be turned on.

- * Is the yellow lead connected?

• No sound from the speakers.

- * Is the speaker output lead short-circuited?

• Sound is distorted.

- * Is the speaker output lead grounded?
- * Are the “-” terminals of L and R speakers grounded in common?

• Unit becomes hot.

- * Is the speaker output lead grounded?
- * Are the “-” terminals of L and R speakers grounded in common?

ВЫЯВЛЕНИЕ НЕИСПРАВНОСТЕЙ

• Сработал предохранитель.

- * Правильно ли подключены черный и красный провода?

• Питание не включается.

- * Подключен ли желтый провод?

• Звук не выводится через громкоговорители.

- * Нет ли короткого замыкания на кабеле выхода громкоговорителей?

• Звук искажен.

- * Заземлен ли провод выхода громкоговорителей?
- * Заземлены ли разъемы “-” правого (R) и левого (L) громкоговорителей?

• Устройство нагревается.

- * Заземлен ли провод выхода громкоговорителей?
- * Заземлены ли разъемы “-” правого (R) и левого (L) громкоговорителей?

1 Remove the audio system originally installed.

Note: Be sure to keep all the screws and parts removed from your car. They are to be used in the future.

2 Install the mounting brackets, removed from the car, to this unit.

3 Connect the wires (see the diagrams on the reverse side).

4 Fix this unit to the car using the screws removed in step 1.

The following example shown is for installation in a Toyota.
For more details, consult your JVC IN-CAR ENTERTAINMENT dealer.

1 Извлеките первоначально установленную аудиосистему.

Примечание: Убедитесь, что все болты и детали системы извлечены из автомобиля. Они понадобятся в дальнейшем.

2 Прикрепите извлеченные из автомобиля крепежные скобы к данному устройству.

3 Подключите провода (см. схемы на обратной стороне).

4 Закрепите данное устройство в машине с помощью извлеченных в действии 1 болтов.

На следующем рисунке показана установка устройства в автомобиле марки Toyota.

За более подробной информацией обратитесь к поставщику автомобильных аудиосистем компании JVC IN-CAR ENTERTAINMENT.

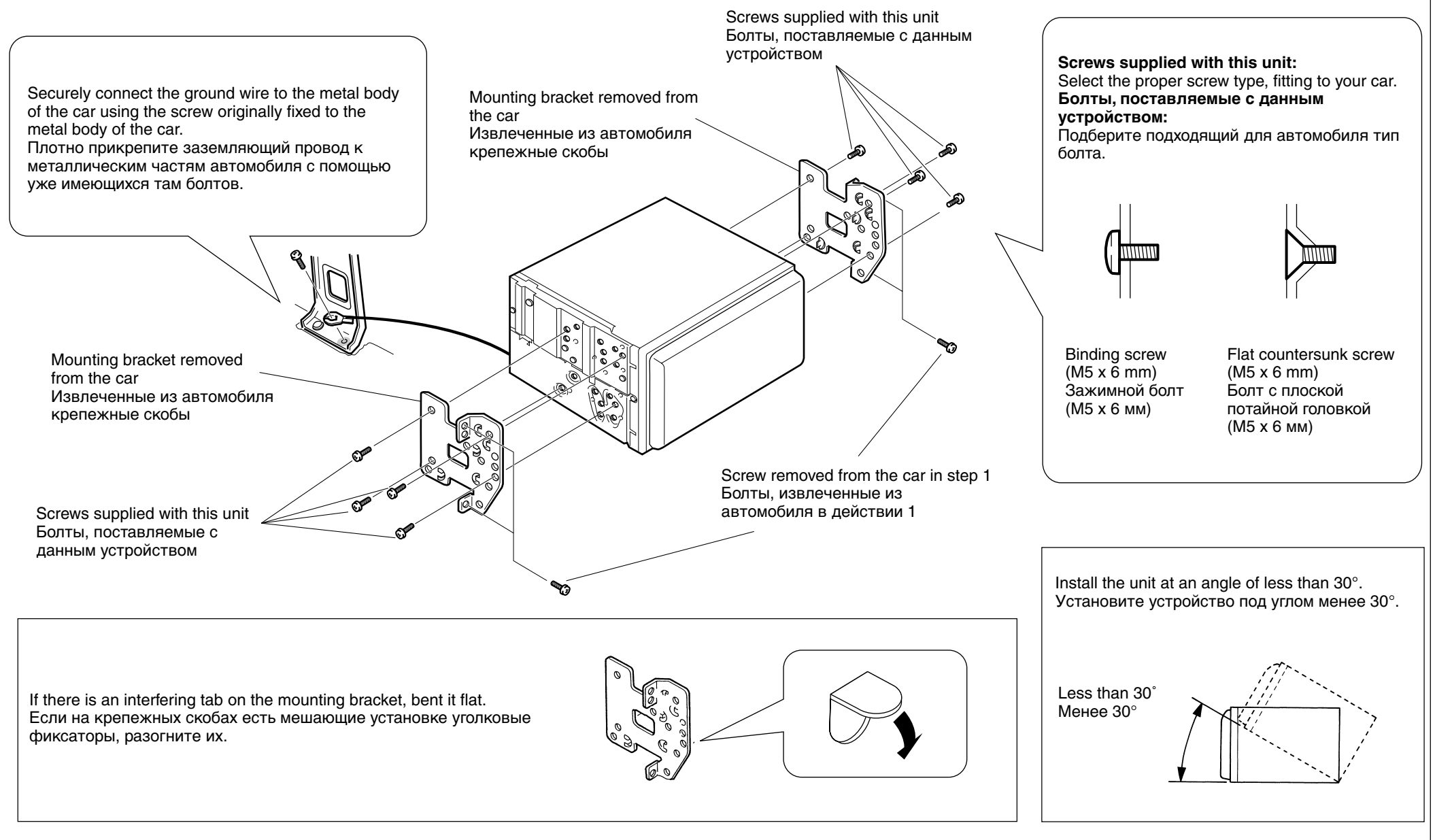

When installing the unit in a Nissan car.

Установка устройства в автомобиле марки Nissan.

Plate for use with a Nissan car
Пластина для автомобилей марки Nissan

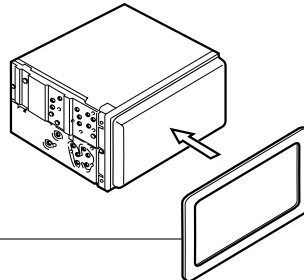

Fix the supplied plate as illustrated.

Закрепите прилагаемую пластину, как показано на рисунке.

ELECTRICAL CONNECTIONS

To prevent short circuits, we recommend that you disconnect the battery's negative terminal and make all electrical connections before installing the unit. If you are not sure how to install this unit correctly, have it installed by a qualified technician.

Note:

This unit is designed to operate on **12 V DC, NEGATIVE ground electrical systems**. If your vehicle does not have this system, a voltage inverter is required, which can be purchased at JVC IN-CAR ENTERTAINMENT dealers.

- Replace the fuse with one of the specified rating. If the fuse blows frequently, consult your JVC IN-CAR ENTERTAINMENT dealer.

- If noise is a problem...

This unit incorporates a noise filter in the power circuit. However, with some vehicles, clicking or other unwanted noise may occur. If this happens, connect the unit's **rear ground terminal** (see connection diagram) to the car's chassis using shorter and thicker cords, such as copper braiding or gauge wire. If noise still persists, consult your JVC IN-CAR ENTERTAINMENT dealer.

- Maximum input of the speakers should be more than 45 W at the rear and 45 W at the front, with an impedance of **4 Ω to 8 Ω**.

- **Be sure to ground this unit to the car's chassis.**

- The heat sink becomes very hot after use. Be careful not to touch it when removing this unit.

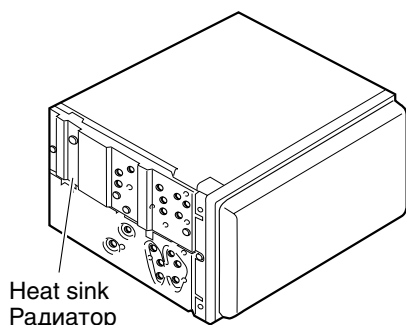

ЭЛЕКТРИЧЕСКИЕ ПОДКЛЮЧЕНИЯ

Для предотвращения коротких замыканий мы рекомендуем Вам отсоединить отрицательный разъем аккумулятора и осуществить все подключения перед установкой устройства. Если Вы не знаете точно, как следует устанавливать это устройство, обратитесь к квалифицированному специалисту.

Примечание:

Это устройство разработано для эксплуатации на **12 В постоянного напряжения с минусом на массе**. Если Ваш автомобиль не имеет этой системы, требуется инвертор напряжения, который может быть приобретен у дилера JVC IN-CAR ENTERTAINMENT.

- Замените предохранитель другим предохранителем указанного класса. Если предохранитель сгорает слишком часто, обратитесь к дилеру JVC IN-CAR ENTERTAINMENT.
- При появлении сильных помех...
Это устройство оснащено фильтром помех в цепи питания. Однако в некоторых случаях возможно появление щелчков и других нежелательных помех. В этом случае подключите **задний разъем заземления** этого устройства (см. схему подключения ниже) к шасси автомобиля при помощи более коротких и толстых проводов. Если помехи не исчезают, обратитесь к дилеру JVC IN-CAR ENTERTAINMENT.
- Максимальная входная мощность громкоговорителей должна быть больше 45 Вт сзади и 45 Вт впереди при полном сопротивлении от **4 Ω до 8 Ω**.
- **Не забудьте заземлить устройство на шасси автомобиля.**
- Радиатор во время использования сильно нагревается. Старайтесь его не трогать во время удаления устройства.

A If your car is equipped with the ISO connector
Если Ваш автомобиль оборудован разъемами ISO

- Connect the ISO connectors as illustrated.
- Подключите разъемы ISO, как показано на иллюстрации.

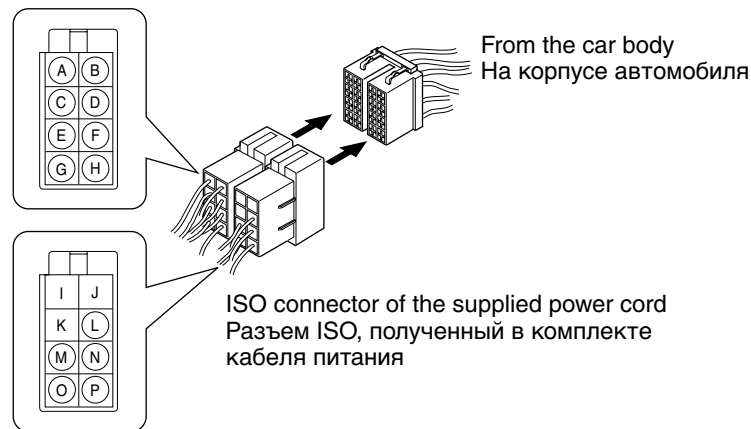

View from the lead side
 Вид со стороны контактов

For some VW/Audi or Opel (Vauxhall) automobile
Для некоторых автомобилей VW/Audi или Opel (Vauxhall)

You may need to modify the wiring of the supplied power cord as illustrated.

- Contact your authorized car dealer before installing this unit.
- Вам может потребоваться изменение соединений полученного в комплекте кабеля питания, как показано на иллюстрации.
- Перед установкой устройства обратитесь к Вашему официальному дилеру автомобиля.

Original wiring
 Исходное соединение

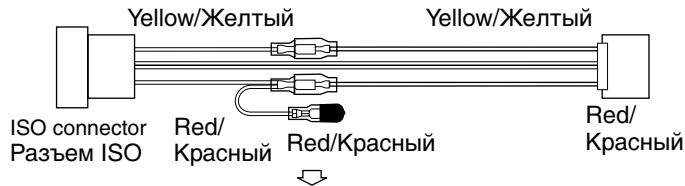

Modified wiring 1
 Модифицированное соединение 1

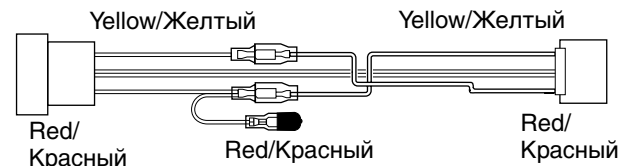

Use modified wiring 2 if the unit does not turn on.
 Если устройство не включается, модифицируйте кабель по схеме 2.

Modified wiring 2
 Модифицированное соединение 2

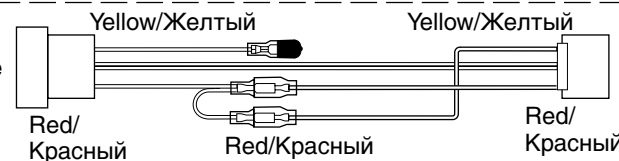

B Connections without using the ISO connectors / Подключение без использования разъемов ISO

Before connecting: Check the wiring in the vehicle carefully. Incorrect connection may cause serious damage to this unit.

The leads of the power cord and those of the connector from the car body may be different in color.

1 Cut the ISO connector.

2 Connect the colored leads of the power cord to the car battery, speakers and power aerial (if any) in the following sequence.

- 1 Black: ground
- 2 Yellow: to car battery (constant 12 V)
- 3 Red: to an accessory terminal
- 4 Blue with white stripe (Remote out): to remote lead of other equipment or power aerial if any (200 mA max.)
- 5 Orange with white stripe: to illumination or small lamp terminal
- 6 Others: to speakers

3 Connect the aerial cord.

4 Finally connect the wiring harness to the unit.

Перед началом подключений: Тщательно проверьте проводку в автомобиле.

Неправильное подключение может привести к серьезному повреждению устройства. Жилы силового кабеля и жилы соединителя от кузова автомобиля могут быть разного цвета.

1 Отрежьте разъем ISO.

2 Подключите цветные провода кабеля питания к аккумулятору, громкоговорителям и автономной антенне (если есть) в следующем порядке:

- 1 Черный: земля
- 2 Желтый: к аккумулятору (постоянный 12 В)
- 3 Красный: к вспомогательному разъему
- 4 Синий с белой полосой (удаленный выход): к удаленному проводу другого оборудования или антенны (макс. 200 мА).
- 5 Оранжевый с белой полосой: к подсветке или ламповому терминалу
- 6 Другие: к громкоговорителям

3 Подключите кабель антенны.

4 В последнюю очередь подключите электропроводку к устройству.

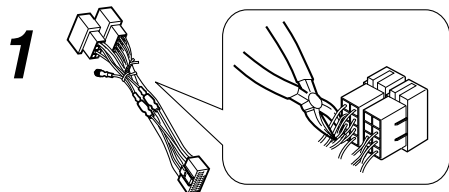

Cut the ISO connector
 Отрежьте разъем ISO

JVC CD changer or another external component
 Устройство автоматической смены компакт-дисков JVC или другое внешнее устройство

- When connecting a CD changer, we recommend to use one of the CH-X series CD changers (except for JVC MP3 compatible CD changer.) If your CD changer is one of the KD-MK series, you need an optional cord (KS-U15K).
- You can also connect an external component such as a portable MD player by connecting the Line Input Adapter KS-U57 (not supplied). (See diagram 4.)
- При подключении устройства автоматической смены компакт-дисков рекомендуется использовать одно из устройств серии CH-X (кроме устройства автоматической смены компакт-дисков компании JVC, совместимого с MP3). Если устройство автоматической смены компакт-дисков относится к серии KD-MK, необходим дополнительный кабель (KS-U15K).
- Можно также подключить внешнее устройство, например, портативный MD-проигрыватель, используя коммуникационный адаптер KS-U57 (не входит в комплект поставки). (См. схему 4.)

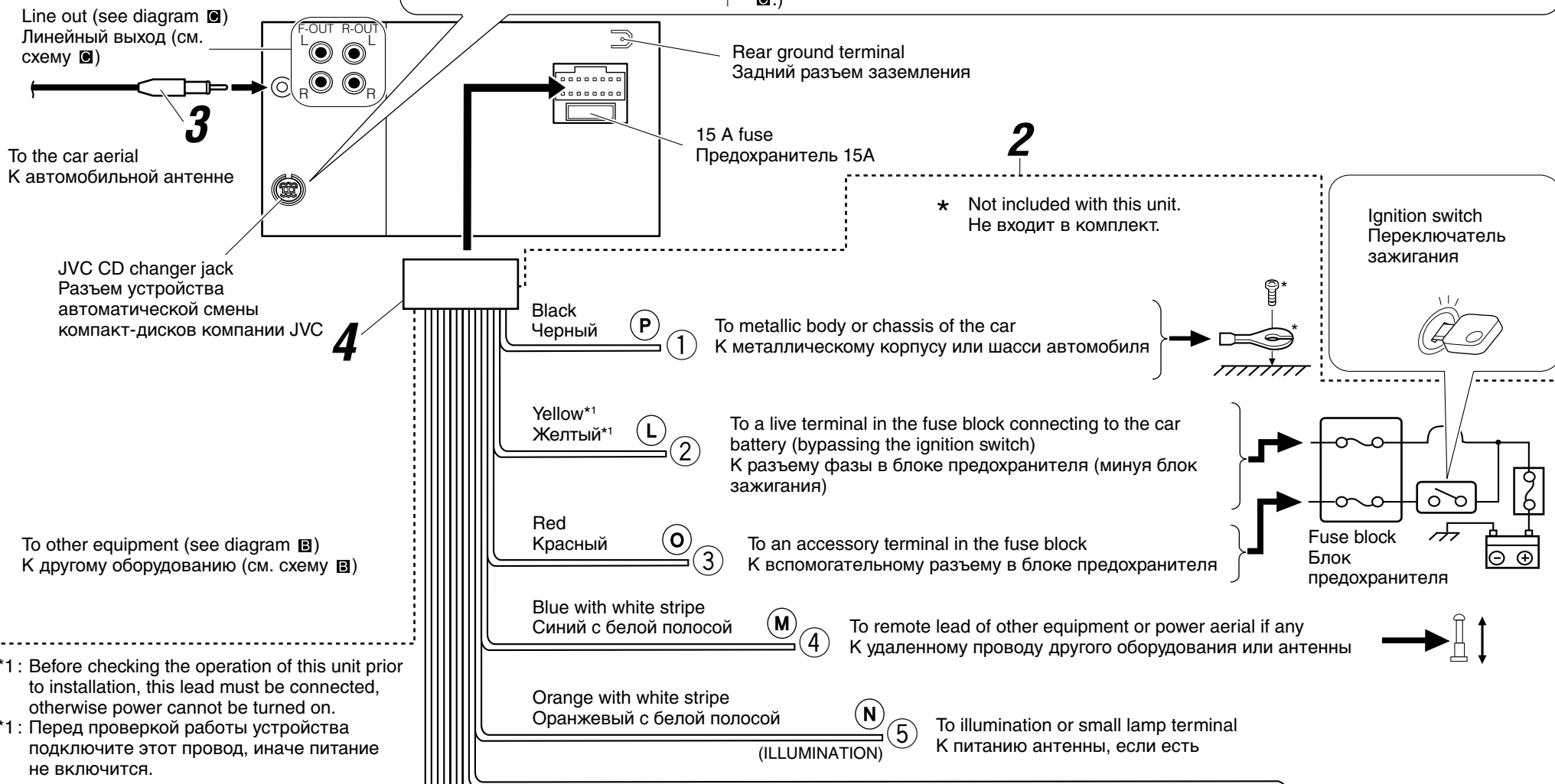

*1: Before checking the operation of this unit prior to installation, this lead must be connected, otherwise power cannot be turned on.
 *1: Перед проверкой работы устройства подключите этот провод, иначе питание не включится.

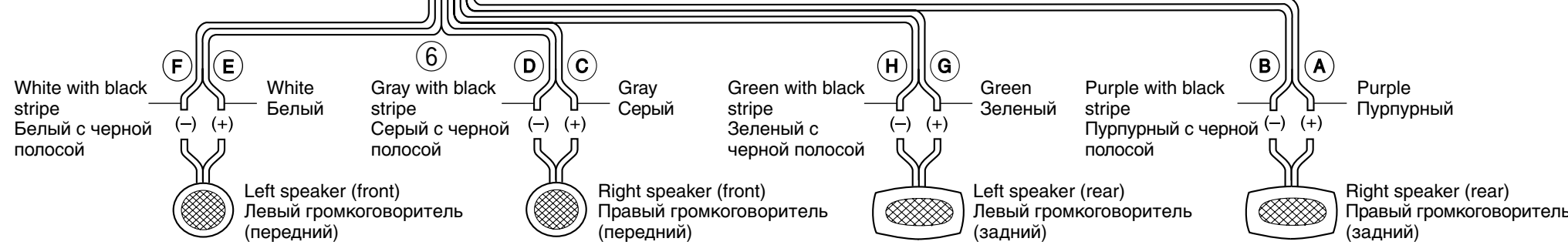

PRECAUTIONS on power supply and speaker connections:

- **DO NOT** connect the speaker leads of the power cord to the car battery; otherwise, the unit will be seriously damaged.
- Connect the black lead (ground), yellow lead (to car battery, constant 12 V), and red lead (to an accessory terminal) correctly.
- **BEFORE** connecting the speaker leads of the power cord to the speakers, check the speaker wiring in your car.
 - If the speaker wiring in your car is as illustrated in Fig. 1 and Fig. 2 below, DO NOT connect the unit using that original speaker wiring. If you do, the unit will be seriously damaged.
 - Redo the speaker wiring so that you can connect the unit to the speakers as illustrated in Fig. 3.
 - If the speaker wiring in your car is as illustrated in Fig. 3, you can connect the unit using the original speaker wiring in your car.
 - If you are not sure of the speaker wiring of your car, consult your car dealer.

ПРЕДОСТЕРЕЖЕНИЯ по питанию и подключению громкоговорителей:

- **НЕ** подключайте провода громкоговорителей к аккумулятору автомобиля, иначе устройство будет повреждено.
- Правильно подключите черный провод (земля), желтый провод (в аккумулятор, постоянный ток 12 В) и красный провод (в вспомогательный разъем).
- **ПЕРЕД** подключением проводов громкоговорителей к кабелю питания громкоговорителя проверьте схему соединений громкоговорителей в Вашем автомобиле.
 - Если проводка громкоговорителей в Вашем автомобиле такая, как показано на приводимых ниже Fig. 1 и Fig. 2, НЕ подключайте устройство с помощью первоначальной проводки громкоговорителей. Если Вы это сделаете, устройство будет серьезно повреждено.
 - Переделайте проводку громкоговорителей так, чтобы Вы могли подключить устройство к громкоговорителям, как это показано на рис. 3.
 - Если проводка громкоговорителей в Вашем автомобиле такая, как показано на Fig. 3, Вы можете подключить устройство с помощью первоначальной проводки громкоговорителей в Вашем автомобиле.
 - Если Вы не знаете соединение громкоговорителей в Вашем автомобиле, обратитесь к Вашему автомобильному дилеру.

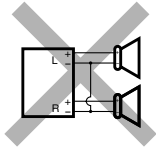

Fig. 1

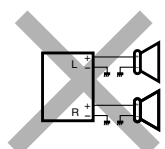

Fig. 2

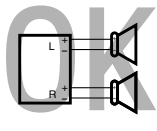
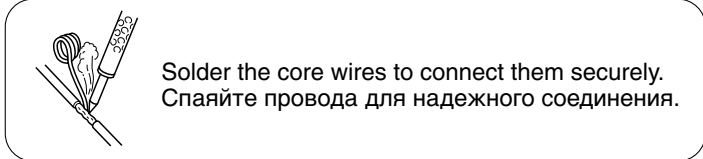
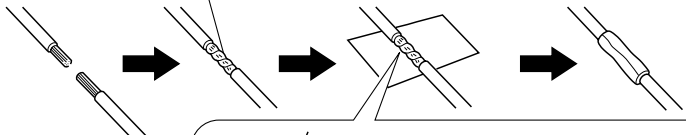

Fig. 3

Connecting the leads / Подключение контактов

Twist the core wires when connecting.
Закрутите концы проводов при соединении.



Solder the core wires to connect them securely.
Спаяйте провода для надежного соединения.

CAUTION / ПРЕДОСТЕРЕЖЕНИЕ:

- To prevent short-circuit, cover the terminals of the UNUSED leads with insulating tape.
- Для предотвращения короткого замыкания заклейте НЕИСПОЛЬЗУЕМЫЕ концы изолирующей лентой.

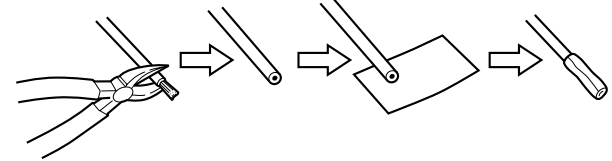

Connections Adding Other Equipment / Подключение других устройств

Amplifier / Усилитель

- You can connect an amplifier and other equipment to upgrade your car stereo system.
- Connect the remote lead (blue with white stripe) to the remote lead of the other equipment so that it can be controlled through this unit.
 - For amplifier only:
 - Connect this unit's line-out terminals to the amplifier's line-in terminals.
 - **Disconnect the speakers from this unit, connect them to the amplifier. Leave the speaker leads of this unit unused.**

- Вы можете подключить усилитель и другое оборудование для модернизации стереосистемы в Вашем автомобиле.
- Подсоедините провод внешнего устройства (синий с белой полосой) к проводу внешнего устройства другого оборудования так, чтобы им можно было управлять с этого устройства.
 - Только для усилителя:
 - Подключите выходные клеммы данного устройства к входным клеммам усилителя.
 - **Отсоедините громкоговорители от данного устройства, подключите их к усилителю. Оставьте провода громкоговорителей данного устройства неиспользованными.**

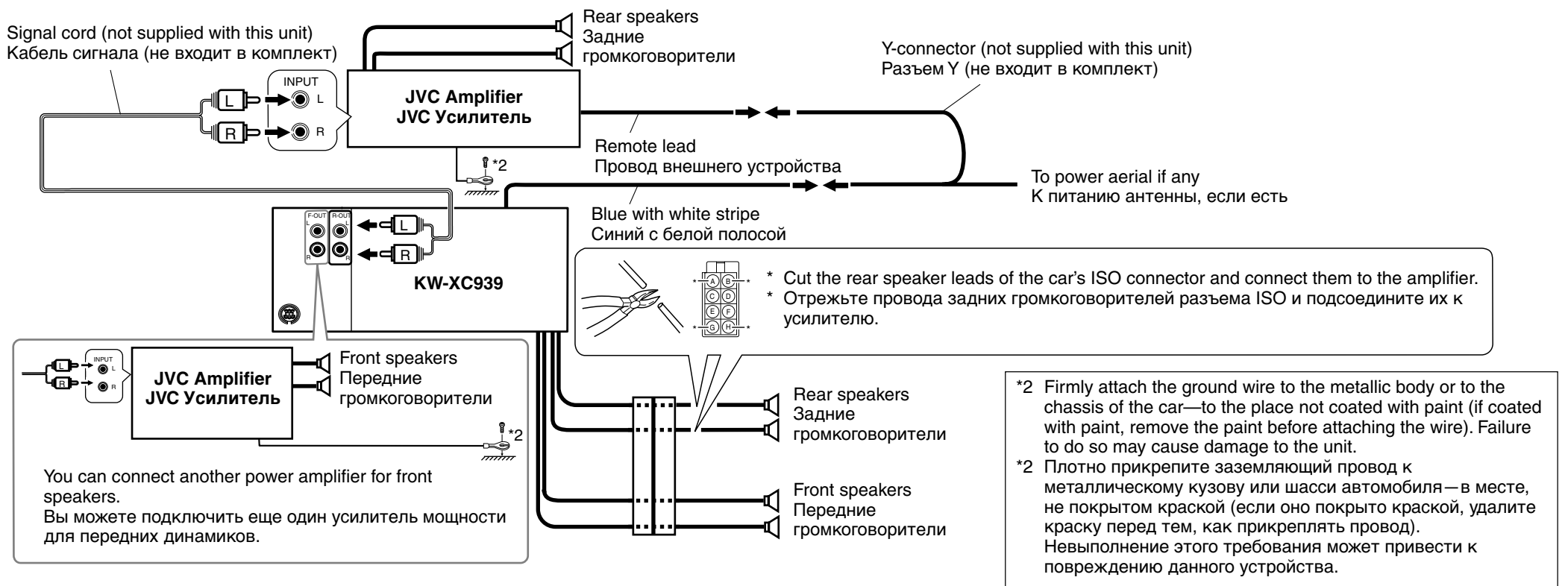

CD changer or another external component / Устройство автоматической смены компакт-дисков или другое внешнее устройство

Cord (supplied with the CD changer)
Шнур (поставляется с устройством автоматической смены компакт-дисков)

Line Input Adapter KS-U57 (not supplied with this unit)
Коммуникационный адаптер KS-U57 (не входит в комплект)

Signal cord (not supplied with this unit)
Кабель сигнала (не входит в комплект)

